

AG06

Actuator with CANopen interface

User manual



Table of contents

1	General Information	6
1.1	Documentation	6
2	Block Diagram	6
3	Display and Control Keys.....	7
3.1	General	7
3.2	LCD display.....	7
3.3	LED displays	7
4	Functional Description	8
4.1	Control of the drive	8
4.1.1	Value input	8
4.1.2	Value selection	8
4.1.3	Operating modes.....	8
4.1.3.1	Positioning mode	8
4.1.3.1.1	Loop positioning.....	9
4.1.3.2	Inching operation.....	10
4.1.3.2.1	Inching mode 1	10
4.1.3.2.2	Inching mode2	10
4.1.3.3	Rotational speed mode.....	10
4.1.4	Current limiting	11
4.2	Manual control (stand-alone operation).....	12
4.2.1	Start inching mode 2.....	12
4.2.2	Specifying the set point and starting the travel order.....	12
4.2.2.1	Example: Starting positioning order to position 500	12
4.2.2.2	Example: Starting positioning order to position -500.....	12
4.3	Menu selection.....	14
4.3.1	Changeable parameters	15
4.3.1.1	Bus parameters	15
4.3.1.2	Positioning.....	16
4.3.1.3	Actuator.....	17
4.3.1.4	Limiting values	17
4.3.1.5	Visualization.....	18
4.3.1.6	Options.....	19
4.3.1.7	Controller parameters.....	21
4.3.2	Readable parameters	21
4.3.3	Error memory.....	22
5	Calibration	22
6	External gear.....	23
7	Warnings / Errors.....	23
7.1	Warnings.....	23

7.2	Errors.....	24
7.2.1	Error codes.....	24
7.3	Input errors.....	25
8	Parameter description.....	25
9	Communication via CAN bus.....	33
9.1	General remarks.....	33
9.1.1	Interface.....	33
9.2	System Status Word.....	34
9.2.1	Meaning of the bits.....	34
9.3	CANopen protocol.....	36
9.3.1	Telegram setup.....	36
9.3.2	Network management (NMT).....	37
9.3.2.1	State Diagramm.....	37
9.3.2.2	NMT Status 'INITIALISATION'.....	37
9.3.2.3	NMT Status 'PRE-OPERATIONAL'.....	37
9.3.2.4	NMT Status 'OPERATIONAL'.....	38
9.3.2.5	NMT Status 'STOPPED'.....	38
9.3.2.6	Switching between communication states.....	38
9.3.3	SYNC-Objekt.....	38
9.3.4	Process Data Objects (PDOs).....	39
9.3.5	Transmit-PDOs.....	39
9.3.5.1	1 st Transmit PDO (TPDO1).....	39
9.3.5.2	3 rd Transmit PDO (TPDO3).....	39
9.3.5.3	4 th Transmit PDO (TPDO4).....	40
9.3.5.4	Transfer types of the Transmit PDOs.....	40
9.3.6	Receive-PDOs.....	41
9.3.6.1	1 st Receive PDO (RPDO1).....	41
9.3.6.2	3 rd Receive PDO (RPDO3).....	41
9.3.6.3	4 th Receive PDO (RPDO4).....	42
9.3.6.4	Transfer types of the Receive PDOs.....	42
9.3.7	Service Data Objects (SDOs).....	43
9.3.7.1	Error code.....	44
9.3.8	Example: Parameterization.....	44
9.3.8.1	Example: Read parameter.....	44
9.3.8.2	Example: Write parameter.....	45
9.3.9	Emergency Object (EMCY).....	46
9.3.9.1	Error Code.....	46
9.3.10	Heartbeat protocol.....	48
9.3.11	Node Guarding.....	49
9.4	State Machine.....	50
9.5	Status word.....	52
9.6	Control word.....	54
9.7	Flowchart of the Profile Position Mode (positioning mode).....	56

9.8	Flowchart of the Profile Velocity Mode operation mode (velocity mode)	57
9.9	Examples.....	58
9.9.1	Example of the Profile Position Mode (positioning mode)	58
9.9.2	Example of the Profile Velocity Mode (velocity mode).....	58
9.10	Overview of CANopen identifiers	59
9.11	Setting the CAN baud rate	59
9.12	EDS file.....	60
9.13	Directory of objects	60
9.13.1	Overview of objects	60
9.13.2	Description of objects.....	63
9.13.2.1	1000 _h : Device Type	63
9.13.2.2	1001 _h : Error Register.....	64
9.13.2.3	1002 _h : Manufacturer Status Register.....	64
9.13.2.4	1003 _h : Pre-defined Error Field.....	65
9.13.2.5	1005 _h : COB-ID Sync Message	65
9.13.2.6	1008 _h : Manufacturer Device Name	66
9.13.2.7	100A _h : Manufacturer Software Version	66
9.13.2.8	100C _h : Guard Time	67
9.13.2.9	100D _h : Life Time Factor	67
9.13.2.10	1011 _h : Restore Default Parameters	67
9.13.2.11	1014 _h : COB-ID Emergency Message.....	69
9.13.2.12	1017 _h : Producer Heartbeat Time.....	70
9.13.2.13	1018 _h : Identity Object.....	70
9.13.2.14	1200 _h : Server SDO Parameter	72
9.13.2.15	1400 _h : 1 st Receive PDO Parameter.....	73
9.13.2.16	1401 _h : 2 nd Receive PDO Parameter	75
9.13.2.17	1402 _h : 3 rd Receive PDO Parameter.....	76
9.13.2.18	1403 _h : 4 th Receive PDO Parameter	78
9.13.2.19	1600 _h : 1 st Receive PDO Mapping Parameter	80
9.13.2.20	1601 _h : 2 nd Receive PDO Mapping Parameter	80
9.13.2.21	1602 _h : 3 rd Receive PDO Mapping Parameter	81
9.13.2.22	1603 _h : 4 th Receive PDO Mapping Parameter	82
9.13.2.23	1800 _h : 1 st Transmit PDO Parameter	83
9.13.2.24	1801 _h : 2 nd Transmit PDO Parameter.....	85
9.13.2.25	1802 _h : 3 rd Transmit PDO Parameter	86
9.13.2.26	1803 _h : 4 th Transmit PDO Parameter	88
9.13.2.27	1A00 _h : 1 st Transmit PDO Mapping Parameter	91
9.13.2.28	1A01 _h : 2 nd Transmit PDO Mapping Parameter	91
9.13.2.29	1A02 _h : 3 rd Transmit PDO Mapping Parameter	92
9.13.2.30	1A03 _h : 4 th Transmit PDO Mapping Parameter	93
9.13.2.31	2001 _h : Manufacturer Offset	94
9.13.2.32	2100 _h : CAN baud rate	94
9.13.2.33	2101 _h : Node-ID	95
9.13.2.34	2102 _h : Gear reduction	95

9.13.2.35 2400 _h : Display and Operation Parameter Set	95
9.13.2.36 2410 _h : Motor Parameter Set	99
9.13.2.37 2412 _h : Spindle Pitch	102
9.13.2.38 2413 _h : Pos Type.....	102
9.13.2.39 2415 _h : Delta Jog.....	103
9.13.2.40 2416 _h : Stop Mode Inching Mode 2.....	103
9.13.2.41 2417 _h : Inpos Mode.....	103
9.13.2.42 2418 _h : Loop Length	104
9.13.2.43 2419 _h : Contouring Error Limit.....	104
9.13.2.44 241A _h : Contouring Error.....	104
9.13.2.45 241B _h : Power Supply Voltage.....	105
9.13.2.46 241C _h : Output Stage Temperature.....	105
9.13.2.47 241E _h : Motor Current.....	106
9.13.2.48 2421 _h : Motor Current Limit.....	106
9.13.2.49 2423 _h : Battery Voltage	106
9.13.2.50 2450 _h : Inching 2 Offset	107
9.13.2.51 2451 _h : Type of acceleration Inching mode 2	107
9.13.2.52 2500 _h : Production Date	107
9.13.2.53 2501 _h : Display Software Version.....	108
9.13.2.54 6040 _h : Control word	108
9.13.2.55 6041 _h : Status word	109
9.13.2.56 6060 _h : Modes of Operation.....	109
9.13.2.57 6061 _h : Modes of Operation Display.....	110
9.13.2.58 6064 _h : Position Actual Value	110
9.13.2.59 6067 _h : Position Window.....	111
9.13.2.60 606C _h : Velocity Actual Value.....	111
9.13.2.61 607A _h : Target Position	111
9.13.2.62 607C _h : Calibration Value	112
9.13.2.63 607D _h : Software Position Limit	112
9.13.2.64 607E _h : Polarity	113
9.13.2.65 6091 _h : Gear Ratio	113
9.13.2.66 60FF _h : Target Velocity	114

1 General Information

This user manual is valid with firmware version PC 2.04 or higher!

1.1 Documentation

The following documents are associated with this document:

- The data sheet describes the technical data, the dimensions, the pin assignment, the accessories and the order key.
- The installation instructions describe the mechanical and electrical installation with all safety-relevant conditions and the associated technical specifications.
- The User manual for actuator commissioning and integration into a fieldbus system.

You can also download these documents at <http://www.siko-global.com/p/ag06>.

2 Block Diagram

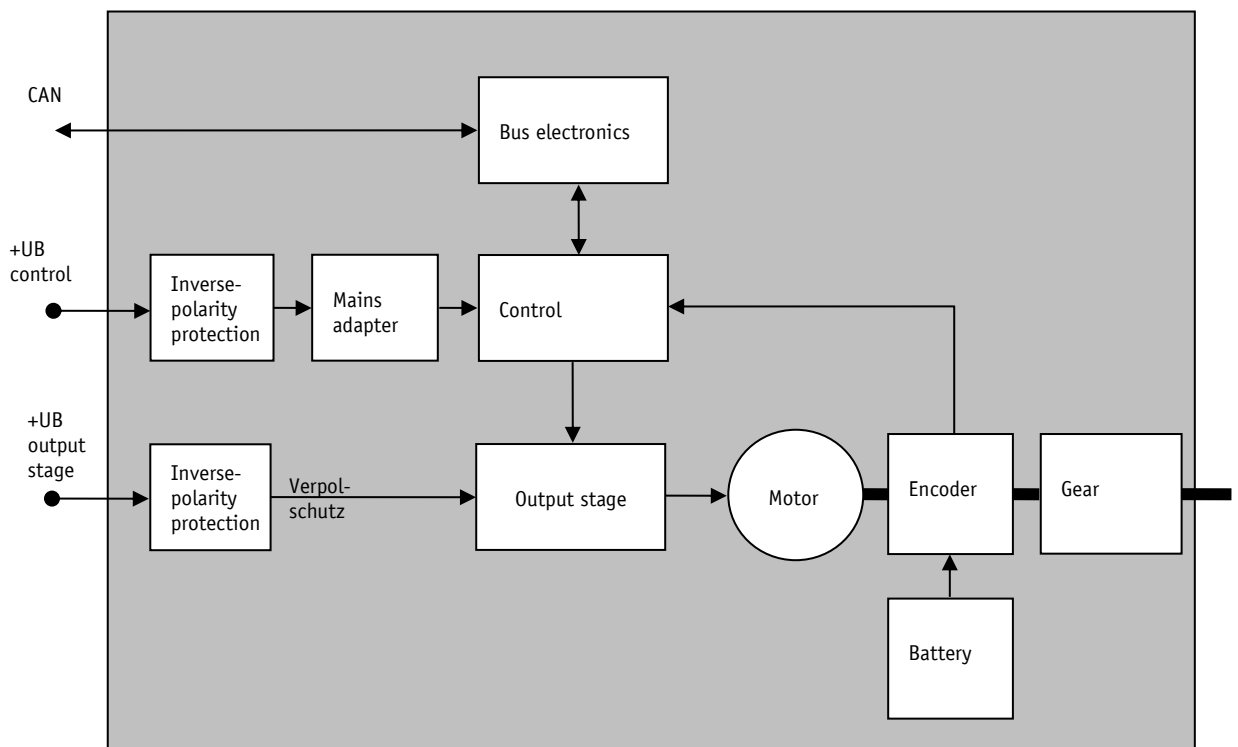

Fig. 1: Block diagram

3 Display and Control Keys

3.1 General

The actuator has a two-line display with special characters and three control keys. The keys serve for actuator parameterization and control. Two LEDs (1, 2) inform about the actuator's operating state.

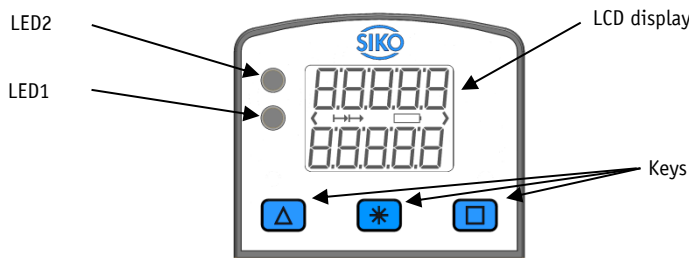

Fig. 2: Control elements

3.2 LCD display

With supply voltage applied to the control, the actual value is displayed in the first line and the set point value with factory settings in the second line.

The value displayed in the 2nd line can be adjusted via parameters.

3.3 LED displays

LED	Colour	State	Description
LED1	green	on	Actuator is within the programmed position window. Supply voltage of the output stage is applied.
		blinking	Actuator is within the programmed position window. Supply voltage of the output stage is missing.
		off	Actuator is outside the programmed position window.
	red	on	Actuator is outside the programmed position window. Supply voltage of the output stage is applied.
		blinking	Actuator is outside the programmed position window. Supply voltage of the output stage is missing.
		off	Actuator is within the programmed position window.
LED2	orange	blinking 2.5 Hz	NMT state: 'PRE-OPERATIONAL'
		on	NMT state: 'OPERATIONAL'
		blinking pulse-duty factor 1:5	
		off	NMT state: 'STOPPED'

Table 1: LED displays

4 Functional Description

4.1 Control of the drive

The drive can be controlled manually (stand-alone) and completely parameterized via the keys. In bus operation you can disable drive control via the keys.

4.1.1 Value input

Enter values via the Δ key and the \square key. Confirm entered values by pressing the $*$ key.

\square - Decimal place selection key

Δ - Value input key

NOTICE	With value input via the keys, the display range is limited to -19999 ... 99999. When entering values beyond this range via CAN interface, "FULL" will be displayed when you select the parameter.
---------------	--

4.1.2 Value selection

For some parameters you can select values from a list. Direct value input is not possible.

You can select a value from the list via the Δ key. Confirm the value by pressing the $*$ key.

4.1.3 Operating modes

The following operating modes are distinguished: positioning mode and speed mode. In the positioning mode there is the additional option of travelling in the inching mode.

4.1.3.1 Positioning mode

In the positioning mode, positioning to the specified set point is executed by means of a ramp function (see Fig. 3), calculated on the basis of the actual position as well as the programmed controller parameters P (proportional factor), I (integral factor), D (differential factor), acceleration and speed.

Upon activation of the travel order, the actuator accelerates to the specified speed with the acceleration programmed. The value of deceleration to the set point is defined by the parameter 'a-Pos' as well.

If the actual position is within the programmed window, this will be signalled by LED1, in the system status word and in the CAN status word. You can define the behaviour of the actuator upon reaching the programmed window.

Changing controller parameters during a positioning process does not influence the current positioning operation.

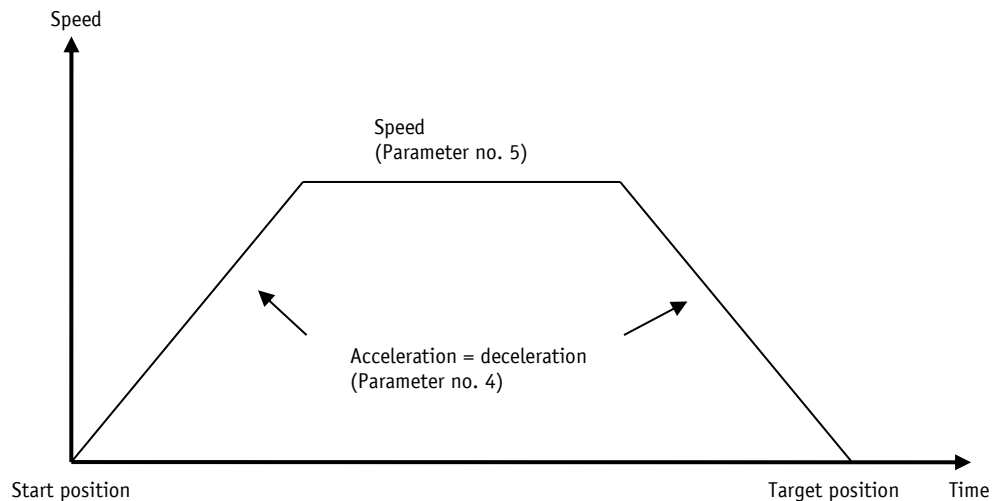

Fig. 3: Ramp travel, direct positioning mode

4.1.3.1.1 Loop positioning

If the actuator is operated on a spindle or an additional gear, the spindle or external gear backlash can be compensated by means of loop positioning. In this case, travelling to the target value is always from the same direction. This direction of approach can be defined.

Example:

The direction from which every target position shall be driven to is positive.

- Case 1 \Rightarrow new position is greater than actual position:
Direct travel to the target position
- Case 2 \Rightarrow new position is smaller than actual position:
The actuator drives beyond the target position by the loop length; afterwards, the set point is approached in positive direction.

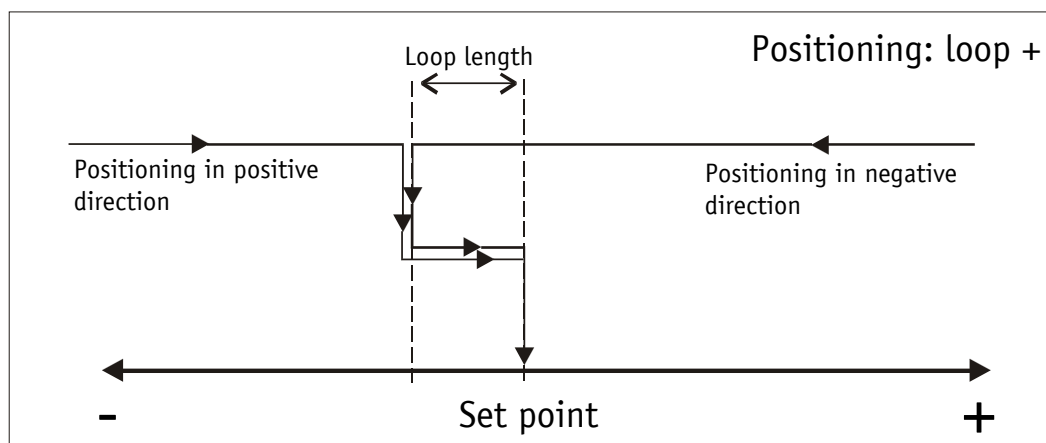

Fig. 4: Positioning Loop+

4.1.3.2 Inching operation

Inching operation is enabled in the 'positioning mode' only. You can program via parameters acceleration as well as speed in the inching mode.

NOTICE	There is no compensation for spindle play (loop positioning) in this operating mode.
---------------	--

4.1.3.2.1 Inching mode 1

The drive travels once from the current actual position by the position 'Delta Tipp' depending on the mathematical sign of the value entered.

'Delta Tipp' <0: negative travel direction

'Delta Tipp' >0: positive travel direction

NOTICE	If the 'Spindle pitch' parameter is programmed to zero, then the travelling way occurs by increments. If 'Spindle pitch' is unequal zero, then the information of the 'Delta Tipp' parameter refers to the travel distance in 1/100 mm.
---------------	---

Reaching of the target position will be signalled accordingly.

The following conditions must be met for enabling the start of inching modes 1 and 2:

- The actuator must not be switched to error
- No active travel job
- Supply voltage of the output stage is applied

NOTICE	If the actual position is outside the programmed limiting values, then travelling from this position in the respective direction is possible by means of inching mode 1 or 2!
---------------	---

4.1.3.2.2 Inching mode2

The actuator travels from the current position as long as the relevant command is active. You can influence the inching speed via two parameters and it will be calculated in the actuator as illustrated in the example below:

v - Tipp (Parameter no. 9) = 10 rpm (can only be changed in the idle state)

Offset inching 2 (Parameter no. 30) = 85 % (can be changed during inching operation)

The resulting inching speed in this example will be:

Inching speed = v - Tipp * Offset inching 2 = 10 rpm * 85 % = 9 rpm

The results are always rounded to integers. The minimum speed is 1 rpm.

4.1.3.3 Rotational speed mode

With the set point enabled, the actuator when in the rotational speed mode accelerates to the target speed and maintains this speed until the set point is disabled or a different target speed specified.

The speed is adjusted immediately to the new value when the rotational target speed is changed.

The arithmetical sign of the set point determines the travel direction in the rotational speed mode.

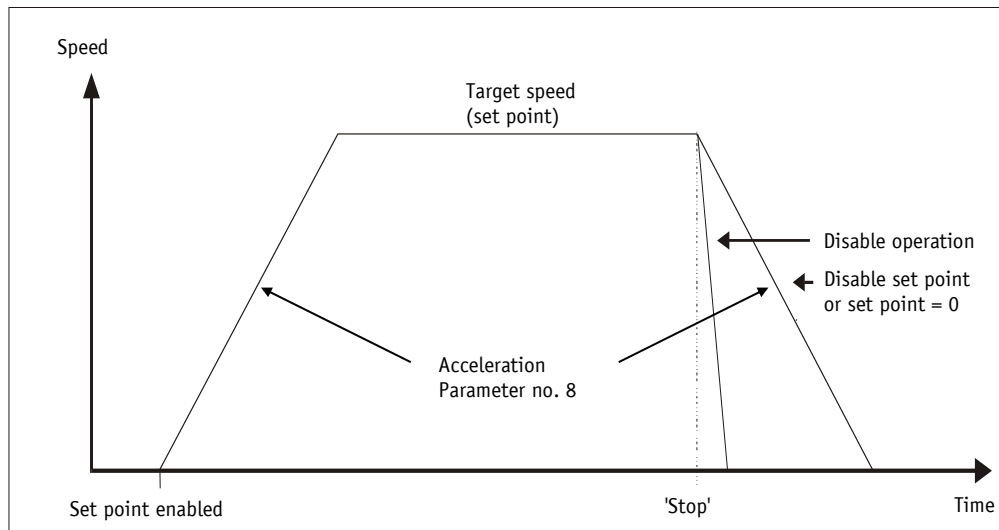

Fig. 5: Ramp rotational speed mode

The following conditions must be met for enabling the start of the rotational speed mode:

- The actuator must not be switched to error
- No active travel job
- Supply voltage of the output stage is applied

NOTICE	Limits 1 + 2 are inactivated in this operational mode.
---------------	--

4.1.4 Current limiting

The actuator is equipped with adjustable current limiting, which serves primarily for protecting the actuator against overload.

With the default value set, the nominal speed indicated on the data sheet is achieved.

Actuator overload results in limiting the motor current to the set value.

As a consequence, the actuator cannot maintain the speed set, the contouring error increases. With the contouring error exceeding the contouring error limit the actuator will enter the state of error: contouring error.

NOTICE	The actual motor current cannot be stated by measuring the supply current. With cycled output stages, the supply current does not correspond to the motor current. The actual motor current can be read out via the interface or indicated on the display.
---------------	--

4.2 Manual control (stand-alone operation)

4.2.1 Start inching mode 2

After applying supply voltage, the actuator will be on the uppermost level of the menu structure (default/delivery state). Positioning mode is active.

Pressing the  key starts left-hand motion (inching operation 2).

Pressing the  key starts right-hand motion (inching operation 2).

Releasing the respective key stops travel movement.











Pressing the  key starts the parameterization/programming mode.

4.2.2 Specifying the set point and starting the travel order

4.2.2.1 Example: Starting positioning order to position 500

Preconditions:

- The display is at the uppermost level of the menu structure (basic state).
- Operating mode: Positioning mode
- Key functions: enabled







	Initial state: normal display First press the  key, then the  key and hold down together.
	The key enable time is counted down.
	After expiry of the key enable time, the input field is released. The first decimal place is active. Press the  key twice to change the active decimal place.
	The third decimal place is active. Press the  key 5 times.
	Value 500 will be displayed. Confirm by pressing the  key to start positioning.

4.2.2.2 Example: Starting positioning order to position -500

Preconditions:

- The display is at the uppermost level of the menu structure (basic state).
- Operating mode: Positioning mode
- Key functions: enabled

NOTICE	For negative values to be entered, set first the value and only afterwards the arithmetical sign. The value 0 cannot be entered.
---------------	--

0 0	Initial state: normal display First press the  key, then the  key and hold down together.
⌚AR9⌚ 3	The key enable time is counted down.
⌚AR9⌚ 00000	After expiry of the key enable time, the input field is released The first decimal place is active and blinks. Press the  key twice to change the active decimal place.
⌚AR9⌚ 00000	The third decimal place is active and blinks. Press the  key 5 times for entering the value.
⌚AR9⌚ 00500	Value 500 will be displayed. Press the  key twice to change the active decimal place.
⌚AR9⌚ 00500	The fifth decimal place is active and blinks. Press the  key 11 times for setting the arithmetical sign.
⌚AR9⌚ -0500	Value -500 will be displayed. Confirm by pressing the  key to start positioning.

4.3 Menu selection

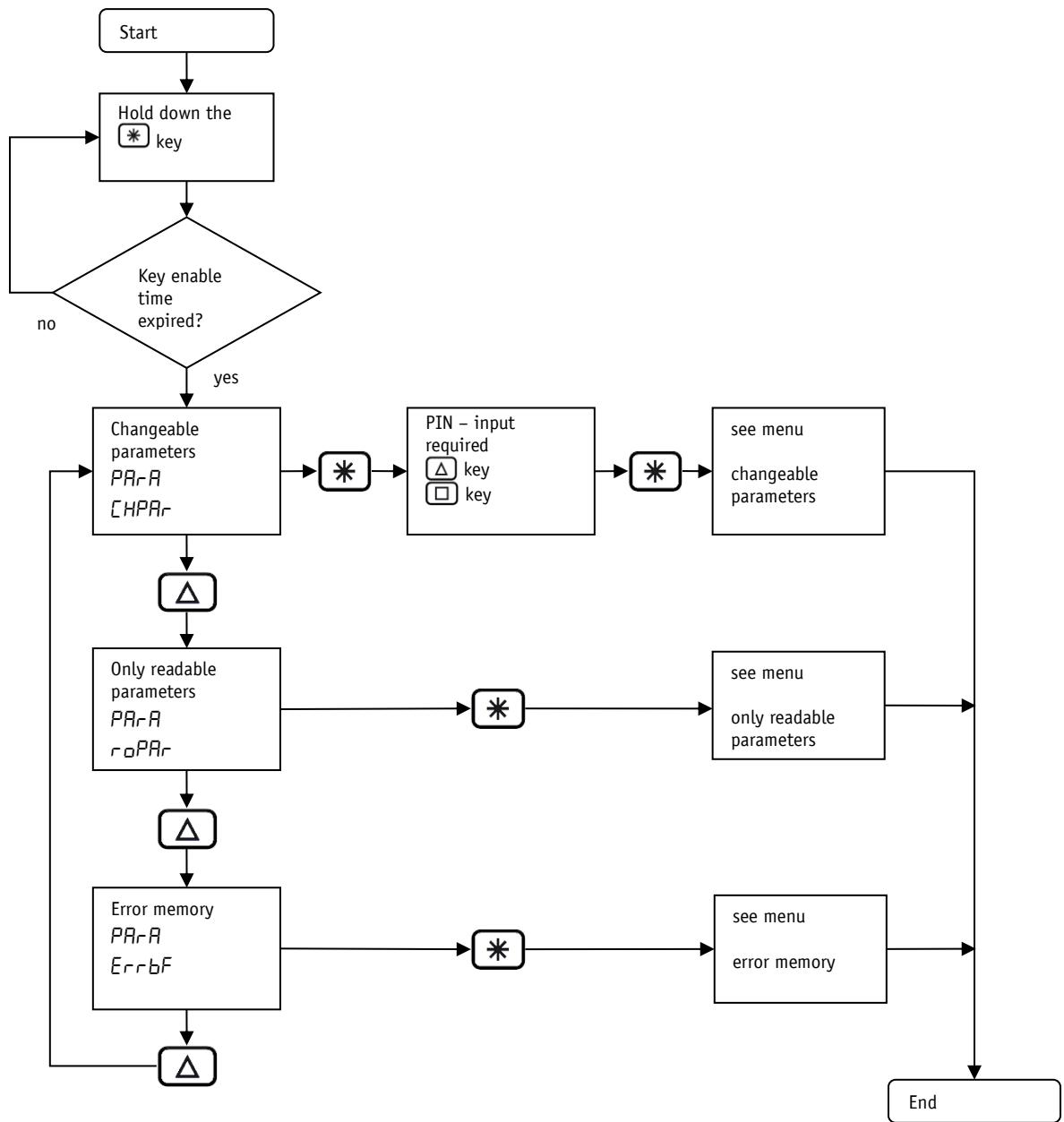

Fig. 6: Menu selection

4.3.1 Changeable parameters

The Changeable parameters menu is subdivided into further sub-menus:

Menu	Sub-menu	Description
PARA [HPAR	PARA	Bus parameters
	bUS	
	PARA POSIT	Positioning
	PARA drU	Actuator
	PARA bound	Limiting values
	PARA VISID	Visualization
	PARA OPTID	Options
	PARA Contr	Controller parameter
PARA QUIT	Exit menu	

Table 2: Changeable parameters menu overview

4.3.1.1 Bus parameters

Menu	PARA [HPAR	Sub-menu	PARA bUS
------	---------------	----------	-------------

Parameter	Description
Id	Node address Value range: 1 - 127 (see chapter 8: Parameter description ⇒ Parameter no. 22)
bAUD	Baud rate Selection: 1000: 1 Mbit/s 800: 800 kbit/s 500: 500 kbit/s 250: 250 kbit/s 125: 125 kbit/s 50: 50 kbit/s 20: 20 kbit/s (see chapter 8: Parameter description ⇒ Parameter no. 33)

Table 3: Bus parameter menu

4.3.1.2 Positioning

Menu	PARA [HPAR	Sub-menu	PARA POS It
------	---------------	----------	----------------

Parameter	Description
EAR9t	Pos window Value range: 0 - 1000 (see chapter 8: Parameter description ⇒ Parameter no. 10)
P I tCH	Spindle pitch Value range: 0 - 99999 (see chapter 8: Parameter description ⇒ Parameter no. 13)
d IU	Display divisor Selection: I: 1 I0: 10 I00: 100 I000: 1000 (see chapter 8: Parameter description ⇒ Parameter no. 43)
CAL Ib	Calibration value Value range: -19999 ... 99999 (see chapter 8: Parameter description ⇒ Parameter no. 14)
LOADP	Selection: no: no calibration CAL Ib: Execute calibration
OFFSt	Offset Value range: -19999 ... 99999 (see chapter 8: Parameter description ⇒ Parameter no. 32)
rotAt	Sense of rotation Selection: Er: i sense of rotation (cw) EEr: e sense of rotation (ccw) (see chapter 8: Parameter description ⇒ Parameter no. 18)
POtYP	Pos Type Selection: d Ir: direct POS: loop+ nES: loop- (see chapter 8: Parameter description ⇒ Parameter no. 19)
LOOP	Loop length Value range: 0 - 30000 (see chapter 8: Parameter description ⇒ Parameter no. 27)

Table 4: Positioning menu

4.3.1.3 Actuator

Menu	PARA [HPAR	Sub-menu	PARA dru
------	---------------	----------	-------------

Parameter	Description
A POS	Acceleration in the positioning mode Value range: 1 - 100 (see chapter 8: Parameter description ⇒ Parameter no. 4)
U POS	Maximum speed in the positioning mode Gear 188:1 ⇒ value range: 1 - 30 Gear 368:1 ⇒ value range: 1 - 15 (see chapter 8: Parameter description ⇒ Parameter no. 5)
A rot	Acceleration in rotational speed mode Value range: 1 - 100 (see chapter 8: Parameter description ⇒ Parameter no. 6)
A InC	Acceleration in inching mode 1/2 Value range: 1 - 100 (see chapter 8: Parameter description ⇒ Parameter no. 8)
U InC	Maximum speed in inching mode 1/2 Gear 188:1 ⇒ value range: 1 - 30 Gear 368:1 ⇒ value range: 1 - 15 (see chapter 8: Parameter description ⇒ Parameter no. 9)
gtrou	Numerator gear ratio Value range: 1 - 10000 (see chapter 8: Parameter description ⇒ Parameter no. 11)
gtrdE	Denominator gear ratio Value range: 1 - 10000 (see chapter 8: Parameter description ⇒ Parameter no. 12)

Table 5: Actuator menu

4.3.1.4 Limiting values

Menu	PARA [HPAR	Sub-menu	PARA bound
------	---------------	----------	---------------

Parameter	Description
EndP1	Limit 1 Value range: -19999 ... 99999 (see chapter 8: Parameter description ⇒ Parameter no. 15)
EndP2	Limit 2 Value range: -19999 ... 99999 (see chapter 8: Parameter description ⇒ Parameter no. 16)

Parameter	Description
<code>LimPE</code>	Current limiting Value range: 25 - 110 (see chapter 8: Parameter description ⇒ Parameter no. 29)
<code>Cont</code>	Contouring error limit Value range: 1 - 30000 (see chapter 8: Parameter description ⇒ Parameter no. 28)

Table 6: Limiting values menu

4.3.1.5 Visualization

Menu	<code>PARA</code> <code>CHPAR</code>	Sub-menu	<code>PARA</code> <code>U 15 10</code>
------	---	----------	---

Parameter	Description
<code>dISPL</code>	Display orientation Selection: <code>0</code> : 0° <code>180</code> : 180° (see chapter 8: Parameter description ⇒ Parameter no. 45)
<code>ORA 2</code>	LED 2 orange function Selection: <code>on</code> : Bus operation display <code>OFF</code> : Off (see chapter 8: Parameter description ⇒ Parameter no. 39)
<code>red 1</code>	Red LED 1 function Selection: <code>on</code> : Indication of the operating status <code>OFF</code> : Off (see chapter 8: Parameter description ⇒ Parameter no. 40)
<code>grn 1</code>	Green LED 1 function Selection: <code>on</code> : Indication of the operating status <code>OFF</code> : Off (see chapter 8: Parameter description ⇒ Parameter no. 41)
<code>dEC 1</code>	Decimal places Selection: <code>0</code> : 0 <code>01</code> : 0.0 <code>002</code> : 0.00 <code>0003</code> : 0.000 <code>00004</code> : 0.0000 (see chapter 8: Parameter description ⇒ Parameter no. 42)

Parameter	Description
<i>Ind I</i>	Direction indication function Selection: <i>ON</i> : On <i>INVS</i> : inverted <i>OFF</i> : Off (see chapter 8: Parameter description ⇒ Parameter no. 44)
<i>L InE2</i>	Displayed value of 2 nd display line Selection: <i>SP</i> : Set point <i>dEG</i> : Output stage temperature <i>CVOLT</i> : Control voltage <i>PVOLT</i> : Output stage voltage <i>VBATT</i> : Battery voltage <i>Idru</i> : Motor current <i>POS</i> : Actual position <i>VELD</i> : Actual rotational speed (see chapter 8: Parameter description ⇒ Parameter no. 49)
<i>tEST</i>	Display test Selection: <i>no</i> : no display test <i>YES</i> : Start display test, pressing the  key stops display test.

Table 7: Visualization menu

4.3.1.6 Options

Menu	<i>PARA</i> <i>CHPAR</i>	Sub-menu	<i>PARA</i> <i>OPT IO</i>
------	-----------------------------	----------	------------------------------

Parameter	Description
<i>cdELA</i>	Key enable time Value range: 1 - 60 (see chapter 8: Parameter description ⇒ Parameter no. 37)
<i>bUEN</i>	Key function enable Selection: <i>ON</i> : Enable all key functions <i>OFF</i> : All key functions disabled (see chapter 8: Parameter description ⇒ Parameter no. 38)
<i>OPtYP</i>	Operating mode Selection: <i>POS</i> : Positioning mode <i>VELD</i> : Rotational speed mode (see chapter 8: Parameter description ⇒ Parameter no. 20)

Parameter	Description
<i>d InCH</i>	Delta Inch Value range: -19999 ... 99999 (see chapter 8: Parameter description ⇒ Parameter no. 17)
<i>InPOS</i>	Inpos mode Selection: <i>ENTR-L</i> : Position control to set point <i>SHORT</i> : Position control Off and short circuit of all motor windings <i>FREE</i> : Position control Off and drive enable (see chapter 8: Parameter description ⇒ Parameter no. 26)
<i>AccYP</i>	Inching mode 2 acceleration type Selection: <i>STAT</i> : static acceleration <i>dYN</i> : incremental acceleration (see chapter 8: Parameter description ⇒ Parameter no. 31)
<i>StopP2</i>	Stop mode inching 2 Selection: <i>HARD</i> : stop with maximum deceleration <i>SOFT</i> : stop with programmed deceleration (see chapter 8: Parameter description ⇒ Parameter no. 25)
<i>OffIn2</i>	Inching 2 Offset Value range: 10 - 100 (see chapter 8: Parameter description ⇒ Parameter no. 30)
<i>Pin</i>	PIN change Value range: 0 - 99999 (see chapter 8: Parameter description ⇒ Parameter no. 48)
<i>LOADP</i>	S commands Selection: <i>no</i> : execute no S command <i>ALL</i> : Set all parameters to default <i>STAND</i> : Set standard parameters to default <i>dr lUE</i> : Set controller parameters to default <i>d ISPL</i> : Set display parameters to default <i>bUS</i> : Set bus parameters to default <i>CAL Ib</i> : Calibration <i>dLErr</i> : Delete error memory

Table 8: Options menu

4.3.1.7 Controller parameters

Menu	PARA [HPAR	Sub-menu	PARA [Contr
------	---------------	----------	----------------

Parameter	Description
[PARP	Controller parameter P Value range: 1 - 500 (see chapter 8: Parameter description ⇒ Parameter no. 1)
[PAR I	Controller parameter I Value range: 0 - 500 (see chapter 8: Parameter description ⇒ Parameter no. 2)
[PARd	Controller parameter D Value range: 0 - 500 (see chapter 8: Parameter description ⇒ Parameter no. 3)

Table 9: Controller parameters menu

4.3.2 Readable parameters

Menu	PARA rOPAR
------	---------------

Parameter	Description
dEG	Current output stage temperature
[uOLt	Current control voltage
PuOLt	Current output stage voltage
UbatE	Current battery voltage
i dru	Current motor current
POS	Current actual position
VELD	Current actual speed
rEdUC	Gear reduction
P dru	Motor rated power
EnCrE	Encoder resolution
U LEd	Display controller software version
U dru	Motor controller software version
SErno	Serial number
dPrOd	Production date

Table 10: Readable parameters menu

4.3.3 Error memory

Menu	PARA ErrbF
------	---------------

Parameter	Description
Errno 0	Number of errors in the error memory (see chapter 8: Parameter description ⇒ Parameter no. 61)
Err 1 xxxxx	Error 1 (see chapter 8: Parameter description ⇒ Parameter no. 62)
Err 2 xxxxx	Error 2 (see chapter 8: Parameter description ⇒ Parameter no. 63)
Err 3 xxxxx	Error 3 (see chapter 8: Parameter description ⇒ Parameter no. 64)
Err 4 xxxxx	Error 4 (see chapter 8: Parameter description ⇒ Parameter no. 65)
Err 5 xxxxx	Error 5 (see chapter 8: Parameter description ⇒ Parameter no. 66)
Err 6 xxxxx	Error 6 (see chapter 8: Parameter description ⇒ Parameter no. 67)
Err 7 xxxxx	Error 7 (see chapter 8: Parameter description ⇒ Parameter no. 68)
Err 8 xxxxx	Error 8 (see chapter 8: Parameter description ⇒ Parameter no. 69)
Err 9 xxxxx	Error 9 (see chapter 8: Parameter description ⇒ Parameter no. 70)
Err 10 xxxxx	Error 10 (see chapter 8: Parameter description ⇒ Parameter no. 71)

Table 11: Error memory menu

xxxxx = Plain text display of error codes (see chapter 7.2.1: [Error codes](#))

5 Calibration

Since the measuring system is an absolute system, calibration is necessary only once with commissioning. With calibration, the calibration value is adopted for calculation of the position value. The following equation is applied in case of calibration:

Position value = 0 + calibration value + offset value

Writing a value onto the calibration value parameter (see chapter 8: [Parameter description](#) ⇒ [Parameter no.14](#)) will result in the adoption of such value as the absolute position for the actuator.

Offset value (see chapter 8: [Parameter description](#) ⇒ [Parameter no. 32](#))

NOTICE

Calibration is only possible when no travel job is active!

6 External gear

If an external gear is used, a factor can be programmed via the parameters no. 11 'ü – numerator' and parameter no. 12 'ü – denominator' in order to include the gear ratio in position sensing.

Example (see Fig. 7):

The actuator is operated on a gear with transmission reduction of 5:1. For this purpose, the parameters 'ü-numerator' and 'ü-denominator' must be programmed as follows:

- Parameter 'ü – numerator': 5
- Parameter 'ü – denominator': 1

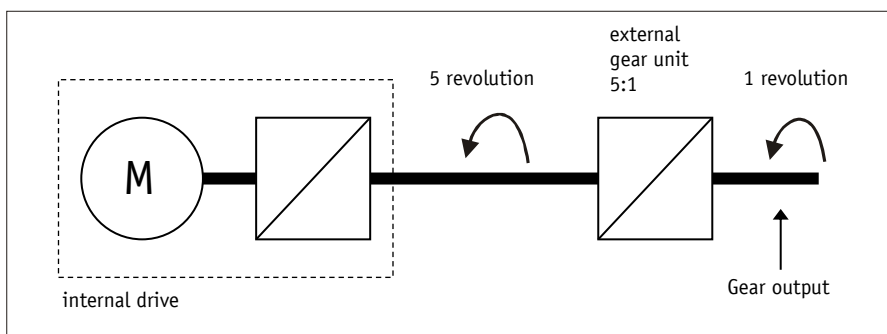

Fig. 7: External gear

Input of an odd gear transmission reduction value is possible according to the following example:

Transmission reduction = 3.78

- Parameter 'ü – numerator': 378
- Parameter 'ü – denominator': 100

7 Warnings / Errors**7.1 Warnings**

Warnings do not influence the operation of the positioning drive. Warnings disappear after removing the cause.

Possible warnings:

- Battery voltage for absolute encoder is below limit \Rightarrow exchange battery within the next 6 months.
- Current limiting active.

7.2 Errors

Errors cause an immediate stop of the positioning drive. Error states are signalled via display. Via interface errors can also be detected:

- The error messages are entered in the error memory in the order of their detection. The last 10 error messages are displayed when the error memory is full.
- The cause of error can be tracked down with the help of the error codes.

7.2.1 Error codes

Display	EMCY- Error codes	Error
noErr	00 00 _h	No error
toCLI	FF 04 _h	Timeout client
toHDS	FF 05 _h	Timeout host
c5CLI	FF 06 _h	Check sum client
c5HDS	FF 07 _h	Check sum host
dEFI n	FF 08 _h	Define mismatch
bAtt	FF 09 _h	Low battery voltage
CUuLt	32 21 _h	Low control electronics voltage
CoULt	32 11 _h	Excess control electronics voltage
POuLt	32 12 _h	Excess power electronics voltage
ouErt	43 10 _h	Output stage excess temperature
LAG	86 11 _h	Contouring error
bLoc	71 21 _h	Shaft blocked
noSUP	32 22 _h	Power electronics: not supplied
btyPE	FF 0A _h	Unknown bus type
Si nCO	73 00 _h	SIN COS monitoring error
q1our	FF 0B _h	Queue 1 overrun
q2our	FF 0C _h	Queue 2 overrun
qUESt	FF 0D _h	Response doesn't match question
CSEEP	FF 0E _h	Check sum EEPROM
ErPAS	FF 02 _h	Error Passive state occurred during an active travel job.
bUSOF	FF 03 _h	Bus Off status
q3our	FF 0F _h	Queue 3 overrun
q4our	FF 10 _h	Queue 4 overrun
CArou	81 10 _h	CAN overrun

Table 12: Error codes

7.3 Input errors

Input errors inform the user about errors that occurred during menu entries. Entries that produce errors are not adopted. Input errors are not saved in the error memory.

Display	Description
UVALUE	Value range exceeded / inappropriate
LIUP	Input value exceeds upper limit
LILD	Input value exceeds lower limit
ACCES	Access not supported
Pr2r0	Write on read only
r2p0	Read on write only
StAtE	Error caused by device status
bUSY	Input disabled due to ongoing EEPROM write access
dJAct	Input disabled due to active travelling job
noPr9	Programming lock activated

8 Parameter description

Column	Explanation
S	"S" = Parameter transferred is saved in the device non-volatilely "- " = Parameter transferred is saved in the device volatilely
C	Parameter class 1 = Standard parameter 2 = Controller parameter 3 = Display parameter 4 = Bus parameter 5 = general parameter

No.	Name	Selection / value	Default	Description	S	C
1	Controller parameter P	1 - 500	300	P gain of controller: valid for all operating modes (positioning mode, speed mode, inching mode)	S	2
2	Controller parameter I	0 - 500	2	I gain of controller: valid for all operating modes (positioning mode, speed mode, inching mode)	S	2
3	Controller parameter D	0 - 500	0	D gain of controller: valid for all operating modes (positioning mode, speed mode, inching mode)	S	2
4	a - pos	1 - 100	50	Acceleration in the positioning mode: values in % 100 % correspond to: Gear 188:1 \Rightarrow 1.06 rps ² Gear 368:1 \Rightarrow 0.54 rps ²	S	2

No.	Name	Selection / value	Default	Description	S	C
5	v - pos	see Description column	10	Maximum speed in the positioning mode: values in rpm Gear 188:1 \Rightarrow 1 – 30 rpm Gear 368:1 \Rightarrow 1 – 15 rpm	S	2
6	a - rot	1 - 100	50	Acceleration in rotational speed mode: values in % 100 % correspond to: Gear 188:1 \Rightarrow 1.06 rps ² Gear 368:1 \Rightarrow 0.54 rps ²	S	2
7				reserved		
8	a - inch	1 - 100	50	Acceleration in inching mode 1/2: values in % 100 % correspond to: Gear 188:1 \Rightarrow 1.06 rps ² Gear 368:1 \Rightarrow 0.54 rps ²	S	2
9	v - inch	see Description column	10	Maximum speed in inching mode 1/2: values in rpm Gear 188:1 \Rightarrow 1 – 30 rpm Gear 368:1 \Rightarrow 1 – 15 rpm	S	2
10	Pos window	0 - 1000	10	Operating mode: Positioning mode: Positioning window If the actual position of the actuator is within the programmed set point \pm this window, this is signalled by setting bit 3 in the status word of the actuator. Spindle pitch = 0: Values refer to increments Spindle pitch > 0: Values refer to travel distance in 1/100 mm Operating mode: Speed mode: If the actual rotational speed is within the target rotational speed \pm this window, this is signalled by setting bit 3 in the system status word of the actuator.	S	1
11	ü - numerator	1 - 10000	1	Numerator gear ratio: a gear factor can be programmed here when a gear is used.	S	1
12	ü - denominator	1 - 10000	1	Denominator gear ratio: a gear factor can be programmed here when a gear is used.	S	1

No.	Name	Selection / value	Default	Description	S	C
13	Spindle pitch	0 - 1000000	0	<p>Spindle pitch: Spindle pitch parameter = 0: Position value is output in increments (720 increments per revolution of the driving shaft). Spindle pitch parameter > 0: (when operating the actuator on a spindle) The position value is output as travelling distance in 1/100 mm , not in increments. Input of target position is now in 1/100 mm as well. e. g. spindle with a pitch of 2 mm ⇒ Spindle pitch parameter = 200.</p>	S	1
14	Calibration value	-999999 to 999999	0	<p>Calibration value: Changes in the calibration value will be directly adopted for the calculation of the position value. Position value = 0 + calibration value + offset value</p>	S	1
15	Limit 1	-9999999 to 9999999	99999	<p>Operating mode: Positioning mode: Limit 1 Spindle pitch = 0: Values refer to increments Spindle pitch > 0: Values refer to travelling distance in 1/100 mm If actuator's position is beyond the range defined by limit 1 and limit 2 (travel range), travelling will only be possible in inching mode in the direction of the travel range. Notice! Limit monitoring is deactivated if 'limit 1' is equal 'limit 2'. Please note that there is a jump of the actual position if the resolution of the absolute encoder is exceeded!</p> <p>Operating mode: Speed mode: irrelevant</p>	S	1

No.	Name	Selection / value	Default	Description	S	C
16	Limit 2	-9999999 to 9999999	-19999	<p>Operating mode: Positioning mode: Limit 2</p> <p>Spindle pitch = 0: Values refer to increments Spindle pitch > 0: Information refers to travel distance in 1/100 mm</p> <p>If actuator's position is beyond the range defined by limit 1 and limit 2 (travel range), travelling will only be possible in inching mode in the direction of the travel range.</p> <p>Notice! Limit monitoring is deactivated if 'limit 1' is equal 'limit 2'. Please note that there is a jump of the actual position if the resolution of the absolute encoder is exceeded!</p> <p>Operating mode: Speed mode: irrelevant</p>	S	1
17	Delta inch	-1000000 to 1000000	720	<p>Delta travelling distance with inching operation 1:</p> <p>Indicates the relative travelling distance. positive value ⇒ positive travelling direction negative value ⇒ negative travelling direction</p> <p>Spindle pitch = 0: Values refer to increments Spindle pitch > 0: Information refers to travel distance in 1/100 mm</p>	S	1
18	Sense of rotation	i, e	i	<p>Counting direction of the measuring system:</p> <p>With shaft rotating counter-clockwise (view on the clamping ring of the actuator)</p> <p>i sense of rotation (cw): ⇒ positive counting direction e sense of rotation (ccw): ⇒ negative counting direction</p>	S	1
19	Pos Type	direct loop + loop -	direct	<p>Operating mode: Positioning mode:</p> <p>Type of positioning direct: direct travelling from actual position to set point loop +: travelling to the set point occurs always in positive direction to compensate for spindle play loop -: travelling to the set point occurs always in negative direction to compensate for spindle play</p> <p>Notice! Loop positioning in positioning mode only.</p> <p>Operating mode: Speed mode: irrelevant</p>	S	1

No.	Name	Selection / value	Default	Description	S	C
20	Operating mode	positioning mode / speed mode	positioning mode	Operating mode: Positioning mode: (see chapter 4.1.3.1: Positioning mode) Operating mode: Speed mode: (see chapter 4.1.3.3: Rotational speed mode)	S	1
21				reserved		
22	Node address	1 - 127	1	Setting the CAN Node-ID	S	5
23				reserved		
24	Set point	see Description column	0	Operating mode: Positioning mode: Indicates absolute target position. Spindle pitch = 0: Values refer to increments Spindle pitch > 0: Information refers to travel distance in 1/100 mm Value range: depends on the preprogrammed target values (parameters 15/16) Operating mode: Speed mode: indicates the target rotational speed in rpm Value range: Gear 188:1 ⇒ max. ±30 rpm Gear 368:1 ⇒ max. ±15 rpm	-	1
25	Stop mode Inch 2	0 - 1	0	Stop mode inching mode 2 / inching key operation Stopping behaviour of inching mode 2 or inching key mode, resp., can be parameterized differently. Stop mode = 0 stop with maximum deceleration Stop mode = 1 stop with programmed deceleration (Parameter no. 8)	S	1
26	Inpos mode	0 - 2	0	Operating mode: Positioning mode: With this parameter you can define the behaviour of the actuator upon reaching the position window: Inpos mode = 0 Position control to set point Inpos mode = 1 Position control OFF and short circuit of the motor windings Inpos mode = 2 Position control OFF and drive enable Operating mode: Speed mode: irrelevant	S	1
27	Loop length	0 - 30000	360	Operating mode: Positioning mode: Spindle pitch = 0: Values refer to increments Spindle pitch > 0: values refer to travel distance in 1/100 mm Operating mode: Speed mode: irrelevant	S	1

No.	Name	Selection / value	Default	Description	S	C
28	Contouring error limit	1 - 30000	400	Contouring error limit: Exceeding the contouring error limit during ongoing positioning results in a "Contouring error" fault.	S	1
29	Current limiting	25 - 110	110	Current limiting: Limiting of surge current. Figures indicate percentage of nominal current	S	1
30	Inching 2 Offset	10 - 100	100	Inching operation 2: The inching speed in Inching operation 2 can be influenced via this parameter Values in percentage of parameter no. 9.	-	1
31	Type of acceleration Inching mode 2	0 - 1	0	Inching operation 2: The type of acceleration can be set with this parameter. 0 = static acceleration Acceleration to final speed in one step as defined under parameter no. 8. 1 = incremental acceleration Acceleration to final speed as defined under parameter no. 8 with the following increments: 4 s to 20 % of final speed 2 s to 50 % of final speed 1 s to 100 % of final speed	S	1
32	Offset	-999999 to 999999	0	Offset value Changes to the offset value are immediately entered in the calculation of the position value. The following equation is applied in case of calibration: Position value = 0 + calibration value + offset value	S	1
33	Baud rate CAN	1 - 7	3	Baud rate of the CAN interface: 1 = 1 Mbit/s 2 = 800 kbit/s 3 = 500 kbit/s 4 = 250 kbit/s 5 = 125 kbit/s 6 = 50 kbit/s 7 = 20 kbit/s Parameter changes become active only after cold start or software reset.	S	5
34				reserved		
35				reserved		
36				reserved		

No.	Name	Selection / value	Default	Description	S	C
37	Key enable time	1 - 60	3	Display / key control: Time in seconds the asterisk key must be held down until menu can be entered or the set point specification is enabled via display.	S	3
38	Key function enable	0 - 1	0	Display / key control: The access to inching mode 2, positioning mode and rotational speed mode functions via keys can be set with this parameter. 0 = all functions via key enabled 1 = all functions via key disabled	S	3
39	LED 2 orange	0 - 1	1	LED 2 orange function: 0 = Off 1 = Bus operation indication	S	3
40	LED 1 red	0 - 1	1	Red LED 1 function: 0 = Off 1 = Indication of the operating status	S	3
41	LED 1 green	0 - 1	1	Green LED 1 function: 0 = Off 1 = Indication of the operating status	S	3
42	Decimal places	0 - 4	0	Display: Input of decimal places 0 = 0 1 = 0.0 2 = 0.00 3 = 0.000 4 = 0.0000	S	3
43	Display divisor	0 - 3	0	Display: Divisor by which the display accuracy is reduced compared with the measurement resolution. 0 = 1 1 = 10 2 = 100 3 = 1000	S	3
44	Direction indication function	0 - 2	0	Display: The direction indicators show the key to be pressed to arrive at the set position window. 0 = On 1 = Inverted 2 = Off	S	3
45	Display orientation	0 - 1	0	Display: Display orientation 0 = 0° 1 = rotated by 180°	S	3
46				reserved		
47				reserved		

No.	Name	Selection / value	Default	Description	S	C
48	PIN Change	0 - 99999	0	Display: Required PIN to be able to change parameters via keys and display.	S	3
49	Displayed value 2 nd display line	0 - 7	0	Display: Parameter to be displayed in the 2 nd line of the display. 0 = Set point 1 = Output stage temperature 2 = Control voltage 3 = Output stage voltage 4 = Battery voltage 5 = Motor current 6 = Actual position 7 = Actual rotational speed	S	3
50	Output stage temperature	Read only	-	Output stage temperature: Values in 1/10 °C	-	-
51	Voltage of control	Read only	-	Control voltage: Values in 1/10 V	-	-
52	Voltage of output stage	Read only	-	Output stage voltage: Values in 1/10 V	-	-
53	Voltage of battery	Read only	-	Battery voltage: Values in 1/100 V	-	-
54	Motor current	Read only	-	Motor current: Values in mA	-	-
55	Actual position	Read only	-	Actual position: Spindle pitch = 0: values in increments Spindle pitch > 0: values in 1/100 mm	-	-
56	Actual rotational speed	Read only	-	Actual rotational speed: Values in rpm	-	-
57	Serial number	Read only	-	Serial number	S	-
58	Production date	Read only	-	Production date: Format: DDMMJJJJ	S	-
59	Software version motor controller	Read only	-	Motor controller software version	S	-
60	Software version display controller	Read only	-	Display controller software version	S	-
61	Number of errors	Read only	-	Number of errors in the error memory	S	-

No.	Name	Selection / value	Default	Description	S	C
62	Error 1	Read only	-	Error 1	S	-
63	Error 2	Read only	-	Error 2	S	-
64	Error 3	Read only	-	Error 3	S	-
65	Error 4	Read only	-	Error 4	S	-
66	Error 5	Read only	-	Error 5	S	-
67	Error 6	Read only	-	Error 6	S	-
68	Error 7	Read only	-	Error 7	S	-
69	Error 8	Read only	-	Error 8	S	-
70	Error 9	Read only	-	Error 9	S	-
71	Error 10	Read only	-	Error 10	S	-
72	Gear reduction	Read only	-	Gear reduction	S	-
73	System Status Word	Read only	-	System status word	-	-
74	Display divisor application	0 - 1	0	Positioning mode only: 0 = The display divisor is applied to the interface's target and actual positions and to the display. 1 = The display divisor is applied to the display only.	S	3

Table 13: Parameter description

9 Communication via CAN bus

9.1 General remarks

This chapter describes activation and parameterization via CAN bus interface.

For the connector pin assignment of the CAN bus interface please refer to the installation instructions.

9.1.1 Interface

The following baud rates are supported:

1 Mbit/s, 800 kbit/s, 500 kbit/s, 250 kbit/s, 125 kbit/s, 50 kbit/s, 20 kbit/s

Termination of the CAN bus line:

If the actuator is at the end of the bus, the CAN bus connection must be terminated by a defined bus terminator.

9.2 System Status Word

The system status word consists of 2 bytes and reflects the state of the actuator (see chapter 8: [Parameter description](#) ⇒ [Parameter no. 73](#)).

High Byte								Low Byte							
Bit number															
15	14	13	12	11	10	9	8	7	6	5	4	3	2	1	0
0	0	1	0	1	0	0	1	0	1	0	0	1	0	0	0
2				9				4				8			

Table 14: Structure of system status word

Example (grey background):

binary: ⇒ 0010 1001 0100 1000

hex: ⇒ 2 9 4 8

9.2.1 Meaning of the bits

The table below informs about the meaning of the individual bits of the status word:

Bit	State	Description
Bit 0	'0'	irrelevant
Bit 1	'0'	irrelevant
Bit 2	'0'	irrelevant
Bit 3		Operating mode: Positioning mode In Position
	'1'	Actual position is within the positioning window of the programmed set point.
	'0'	Actual position is beyond the positioning window of the programmed set point.
		Operating mode: Speed mode: In Position
	'1'	Actual rotational speed is within the specified tolerance window of the target speed.
	'0'	Actual speed is outside the specified tolerance window.
Bit 4		Actuator travels:
	'1'	Actuator travels.
	'0'	Drive stands still (rotational speed <2 rpm).
Bit 5		Operating mode: Positioning mode, upper limit
	'1'	Actual position is above the programmed limiting value. Travelling is possible only in negative direction in inching mode.
	'0'	Actual position is below the programmed limiting value.
	'0'	Operating mode: Speed mode: irrelevant
Bit 6		Operating mode: Positioning mode, lower limit
	'1'	Actual position is below the programmed limiting value. Travelling is possible only in positive direction in inching mode.
	'0'	Actual position is above the programmed limiting value.
	'0'	Operating mode: Speed mode: irrelevant

Bit	State	Description
Bit 7		Driver state:
	'1'	Motor is enabled.
	'0'	Motor in control.
Bit 8		Error:
	'1'	Actuator has switched to error. The cause of the error must be removed and acknowledged.
	'0'	No error present.
Bit 9		Operating mode: Positioning mode: Loop travel
	'1'	If travel direction unequal start direction (with loop travel).
	'0'	If travel direction equal start direction.
	'0'	Operating mode: Speed mode: irrelevant
Bit 10		Output stage supply voltage:
	'1'	No voltage, no travelling possible.
	'0'	Voltage applied.
Bit 11		Ready for travel:
	'1'	Not ready for travel
	'0'	Ready for travel: - Actuator not in error state - No active positioning - Supply voltage of the output stage is applied - Actual position within limits (only positioning mode)
Bit 12		Battery voltage:
	'1'	Battery voltage <2.6 V
	'0'	Battery voltage o. k.
Bit 13		Current limiting:
	'1'	Current limiting active.
	'0'	Current limiting not active.
Bit 14		Operating mode: Positioning mode Status
	'1'	Positioning active in positioning mode.
	'0'	Positioning inactive.
		Operating mode: Speed mode: Status
	'1'	Enable target speed.
	'0'	Target speed disabled.
Bit 15		Contouring error:
	'1'	Contouring error ⇒ the actuator cannot reach the pre-set speed due to too high load. The actuator switches the contouring error fault. Remedy: reduce programmed speed!
	'0'	No contouring error ⇒ actual speed corresponds to target speed.

Table 15: System Status Word

9.3 CANopen protocol

The CANopen protocol is based on the CANopen communication profile CiA DS-301 V4.0 as well as the device profile Drives and Motion Control CiA DSP-402 V2.0.

The details required for a better understanding and possible deviations are included in this documentation.

9.3.1 Telegram setup

The data telegram of a CAN message consists of the following fields:

SOF:

Start of Frame ⇒ start bit of the telegram

Identifier:

The Identifier field contains the identifier as well as bits for the recognition of the length of the identifiers (11 or 29 bits). The identifier determines the priority of the message. Via identifier, CANopen determines additionally the device address, channel selection as well as data direction.

Control field:

Contains bits concerning the number of user data and determines whether a data frame or RTR frame (Remote Transfer Request frame) is concerned.

Data field:

Contains up to 8 bytes of user data. The user data has a different meaning depending on the channel selection.

CRC:

Contains bits for error detection.

ACK/EOF:

The ACK/EOF field contains telegram acknowledgement bits as well as bits for determining the end of telegram.

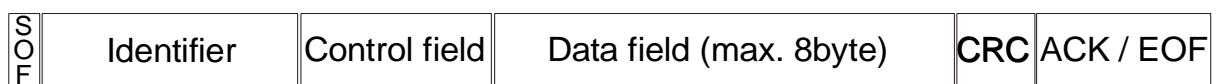

Fig. 8: Telegram setup

For a detailed description of the telegram please refer to the comprehensive CAN literature.

For simplification, only identifier and data field will be dealt with in the subsequent telegram descriptions.

9.3.2 Network management (NMT)

The master configures, manages and monitors network nodes via the NMT service.

For switching between the four available communication states of a network node, 'INITIALISATION', 'PRE-OPERATIONAL', 'OPERATIONAL' and 'STOPPED', telegrams with the identifier '0' as well as 2 bytes of user data are used. The identifier of the NMT protocol is limited to 11 bits.

9.3.2.1 State Diagramm

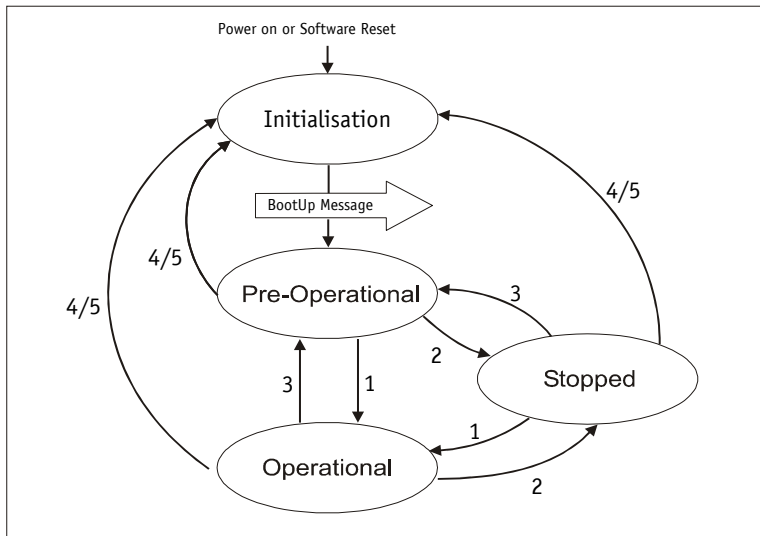

Fig. 9: State Diagramm

9.3.2.2 NMT Status 'INITIALISATION'

The actuator is not involved in the bus actions in this state. All hardware and software components are initialised. This state is attained after switching on the device or after receipt of the command code 82_h of the own or global addresses. After completion of initialisation, the actuator goes automatically into the 'PRE-OPERATIONAL' status. This is signalled by a boot-up message consisting of the identifier '1791 + Node ID' and a data byte having the value '0'.

9.3.2.3 NMT Status 'PRE-OPERATIONAL'

The exchange of parameterization data (SDOs) between the actuator and the bus master is enabled. However, no process data (PDOs) is transferred. Furthermore, the State Machine of the actuator is set to the 'SWITCH ON DISABLED' state (see chapter 9.4: State Machine) and the motor enabled.

NOTICE

PDO parameters can be changed in this state only!

9.3.2.4 NMT Status 'OPERATIONAL'

Exchange of process and parameterization data is enabled.

Hint: TPDOs with the 254 transfer type are sent with the transition into the 'OPERATIONAL' NMT status.

9.3.2.5 NMT Status 'STOPPED'

Exchange of all data is stopped with the exception of the heartbeat message (see chapter [9.3.10: Heartbeat protocol](#)) and the node guarding protocol, if active (see chapter [9.3.11: Node Guarding](#)). Only NMT communication is enabled. Furthermore, the State Machine of the actuator is set to the 'SWITCH ON DISABLED' state (see chapter [9.4: State Machine](#)) and the motor enabled.

9.3.2.6 Switching between communication states

The network master can switch between the communication states by sending the following telegrams with the identifier '0'.

Status change		Data 1	Data 2
from	to		
PRE-OPERATIONAL / STOPPED	OPERATIONAL (1)	01h	xx
OPERATIONAL / PRE-OPERATIONAL	STOPPED (2)	02h	xx
OPERATIONAL / STOPPED	PRE-OPERATIONAL (3)	80h	xx
OPERATIONAL / PRE-OPERATIONAL / STOPPED	INITIALISATION (4/5)	81h	xx
OPERATIONAL / PRE-OPERATIONAL / STOPPED	INITIALISATION * (4/5)	82h	xx

Table 16: Switching between communication state

* Cold start is triggered (Power on)

xx = 0 ⇒ the telegram is intended for all devices on the bus

xx = device address ⇒ the telegram is only intended for the device with the respective address.

9.3.3 SYNC-Objekt

CANopen enables the simultaneous query of all inputs and the simultaneous setting of all outputs. The synchronization telegram (SYNC), a CAN message with high priority, which contains no user data serves for this purpose.

The identifier of the Sync object can be set via object 1005_h (see chapter [9.13.2: Description of objects](#)).

9.3.4 Process Data Objects (PDOs)

Process data objects serve for fast exchange of short process data. Process data objects are transferred event-triggered, cyclically or on request. A maximum of 8 bytes of user data can be transferred in a PDO.

NOTICE

The exchange of PDOs is enabled in the NMT status Operational only!

The actuator provides 3 Transmit PDOs (process data from the actuator \Rightarrow NMT master) and 3 Receive PDOs (process data from the NMT master \Rightarrow to the actuator). The Receive PDOs, RPDO1, RPDO3, RPDO4 and the Transmit PDOs, TPDO1, TPDO3 and TPDO4 are supported according to the Device Profil 'Drives and Motion Control CIA DSP-402 Version 2.0'.

9.3.5 Transmit-PDOs

9.3.5.1 1st Transmit PDO (TPDO1)

The first Transmit PDO contains 2 user data bytes on which the status word of the actuator is mapped.

The Transmit PDO is transferred by the actuator asynchronously as a standard. Together with the Receive PDO1 on which the control word of the state machine is mapped it forms a handshake connection (acknowledgement operation) between the higher-order control and the drive controller.

It is, therefore not recommended to change the transfer type of the TDO1.

The COB-ID of the first Transmit PDO is programmed to $180_h + \text{Node-ID}$ by default. The communication parameters are set via the object 1800_h (1st Transmit PDO parameter).

1 st Transmit PDO		
11/29 Bit Identifier	Byte 1	Byte 2
	LSB	MSB
	Status word (object 6041_h)	

Table 17: 1st Transmit PDO

9.3.5.2 3rd Transmit PDO (TPDO3)

The third Transmit PDO contains 6 user data bytes on which the status word and the current position value of the actuator are mapped.

The Transmit PDO3 is transferred only by a RTR frame (remote transfer request) as a standard, i. e., a higher-order control must request the TDO3 (polling). Synchronous transfer (value 0 to 240) can be set via the SYNC object or the time-triggered transfer (value 255) by means of a local cycle (event timer) as an alternative to polling.

The COB-ID of the third Transmit PDO is programmed to $380_h + \text{Node-ID}$ by default. The communication parameters are set via the object 1802_h (3rd Transmit PDO parameter).

3 rd Transmit PDO						
11/29 Bit Identifier	Byte 1	Byte 2	Byte 3	Byte 4	Byte 5	Byte 6
	LSB	MSB	LSB	NSB	NSB	MSB
	Status word (object 6041 _h)		Position value (object 6064 _h)			

Table 18: 3rd Transmit PDO

9.3.5.3 4th Transmit PDO (TPD04)

The fourth Transmit PDO contains 6 user data bytes on which the status word and the actual velocity of the actuator is mapped. The Transmit PDO4 is transferred only by a RTR frame (remote transfer request) as a standard, i. e., a higher-order control must request the TDO4 (polling). Synchronous transfer (value 0 to 240) can be set via the SYNC object or the time-triggered transfer (value 255) by means of a local cycle (event timer) as an alternative to polling.

The COB-ID of the fourth Transmit PDO is programmed to 480_h + Node-ID by default. The communication parameters are set via the object 1803_h (4th Transmit PDO parameter).

4 th Transmit PDO						
11/29 Bit Identifier	Byte 1	Byte 2	Byte 3	Byte 4	Byte 5	Byte 6
	LSB	MSB	LSB	NSB	NSB	MSB
	Status word (object 6041 _h)		Actual velocity (object 606C _h)			

Table 19: 4th Transmit PDO

9.3.5.4 Transfer types of the Transmit PDOs

Different transfer types can be set for the individual PDOs via objects 1800_h until 1803_h 'Transmit PDO Parameter' sub-index 2 (see chapter 9.13.2: [Description of objects](#)).

Synchronous:

Sub-index 2 (transfer type) = 0:

The Transmit PDO is sent by the actuator upon receipt of each SYNC telegram.

Sub-index 2 (transfer type) = 1 ... 240:

The Transmit PDO is sent by the actuator only after receipt of the number of SYNC telegrams indicated under 'transfer type'.

Asynchronous:

Event-Triggered: Sub-index 2 (transfer type) = 254

A PDO is transmitted with every change of a mapped object and in a time-controlled way. The Event Timer can be deactivated.

Time-Triggered: Sub-index 2 (transfer type) = 255

The PDOs are transferred time-triggered.

The sub-index 5 'Event Timer' of the Transmit PDO parameters indicates the cycle time in milliseconds.

Sub-index 2 (transfer type) = 253

The Transmit PDO is sent after receipt of a RTR frame with the identifier of the respective Transmit PDO.

9.3.6 Receive-PDOs

9.3.6.1 1st Receive PDO (RPDO1)

The first Receive PDO contains 2 user data bytes on which the status word of the actuator is mapped.

The control word in the Receive PDO1 serves for controlling the operation transitions of the state machine. The Receive PDO1 serves for getting the state machine into the OPERATION ENABLED state or for commanding travel interruption or cancellation of travel during running drive movement, respectively.

The drive controller processes the Receive PDO1 asynchronously as a standard. Together with the Transmit PDO1 on which the control word of the state machine is mapped it forms a handshake connection (acknowledgement operation) between the higher-order control and the drive controller.

It is, therefore not recommended to change the transfer type of the RPDO1.

The COB-ID of the first Receive PDO is programmed to $200_h + \text{Node-ID}$ by default. The communication parameters are set via the object 1400_h (1st Receive PDO parameter).

1 st Receive PDO		
11/29 Bit Identifier	Byte 1	Byte 2
	LSB	MSB
	Control word (object 6040_h)	

Table 20: 1st Receive PDO

9.3.6.2 3rd Receive PDO (RPDO3)

The third Receive PDO is assigned to the operation mode 'Profile Position Mode' (positioning mode) and contains 6 user data bytes on which the control word as well as the current target value for the actuator is mapped.

The position transferred is taken over as the absolute target position. Drive movement in the positioning mode can be executed from the 'OPERATION ENABLED' state of the state machine only.

The drive controller processes the Receive PDO3 asynchronously as a standard. Together with the Transmit PDO1 on which the status word of the state machine is mapped, it forms a handshake connection (acknowledgement operation) between the higher-order control and the drive controller.

Synchronous transfer type (value 0) can be set to enable synchronous start of more than one drive. The data of the RPDO3 is processed only after receipt of the next SYNC telegram in this case (see chapter 9.3.3: SYNC-Objekt).

The COB-ID of the third Transmit PDO is programmed to $400_h + \text{Node-ID}$ by default. The communication parameters are set via the object 1402_h (3rd Receive PDO parameter).

3 rd Receive PDO						
11/29 Bit Identifier	Byte 1	Byte 2	Byte 3	Byte 4	Byte 5	Byte 6
	LSB	MSB	LSB	NSB	NSB	MSB
	Control word (object 6040_h)		Target value (object $607A_h$)			

Table 21: 3rd Receive PDO

9.3.6.3 4th Receive PDO (RPDO4)

The fourth Receive PDO is assigned to the operation mode 'Velocity Mode' and contains 6 user data bytes on which the control word as well as the current target velocity for the actuator are mapped.

A driving movement in positive or negative sense of rotation is started via the control word in the Receive PDO4. Drive movement in the velocity mode can be executed from the 'OPERATION ENABLED' state of the state machine only.

The drive controller processes the Receive PDO4 asynchronously as a standard. Together with the Transmit PDO1 onto which the status word of the state machine is mapped, it forms a handshake connection (acknowledgement operation) between the higher-order control and the drive controller.

Synchronous transfer type (value 0) can be set to enable synchronous start of more than one drive. The data of the RPDO4 is processed only after receipt of the next SYNC telegram in this case (see chapter 9.3.3: SYNC-Objekt).

The COB-ID of the fourth Transmit PDO is programmed to $500_h + \text{Node-ID}$ by default. The communication parameters are set via the object 1403_h (4th Receive PDO parameter).

4 th Receive PDO						
11/29 Bit Identifier	Byte 1	Byte 2	Byte 3	Byte 4	Byte 5	Byte 6
	LSB	MSB	LSB	NSB	NSB	MSB
	Control word (object 6040_h)		Target velocity (object $60FF_h$)			

Table 22: 4th Receive PDO

9.3.6.4 Transfer types of the Receive PDOs

Different transfer types can be set for the individual PDOs via objects 1400_h until 1403_h 'Receive PDO Parameter' sub-index 2 (see chapter 9.13.2: Description of objects).

Synchronous:

Sub-index 2 (transfer type) = 0 ... 240

In the synchronous transfer type, the Receive PDOs are processed only after receipt of a SYNC telegram.

Asynchronous:

Sub-index 2 (transfer type) = 254 ... 255

In the asynchronous transfer type, the Receive PDOs are processed by the actuator immediately after receipt of the Receive PDO.

9.3.7 Service Data Objects (SDOs)

Service Data Objects (SDOs) serve in the first place for transferring device configuration parameters.

8 bytes of user data are always transferred in a SDO. The identifier is set to 11 bits and cannot be changed.

NOTICE	The exchange of SDOs is enabled in the NMT statuses "Pre-Operational" as well as "Operational"!
---------------	---

There is each one COB ID for data transfer from the master to the actuator (COB-ID $600_h + \text{Node-ID}$) and one COB ID for data transfer from the actuator to the master (COB-ID $580_h + \text{Node-ID}$).

Data transfer is always initiated and controlled by the master.

The COB IDs for the Service Data Objects cannot be changed.

SDO Telegram								
11 Bit Identifier	Byte 1	Byte 2	Byte 3	Byte 4	Byte 5	Byte 6	Byte 7	Byte 8
	Command	Parameter index	Sub-index	Data 1	Data 2	Data 3	Data 4	

Table 23: Setup of the SDO telegram

Byte 1: Command code

The first byte contains the command code of the SDO telegram. The following table lists the available commands and describes their meaning.

Command	Command code hexadecimal	Command code decimal	Meaning
Write Request	23_h	35	send parameters (4 data byte)
Write Request	$2B_h$	43	send parameters (2 data byte)
Write Request	$2F_h$	47	send parameters (1 data byte)
Write Response	60_h	96	response of Write Request
Read Request	40_h	64	request of a parameter
Read Response	43_h	67	response to the request (4 data byte)
Read Response	$4B_h$	75	response to the request (2 data byte)
Read Response	$4F_h$	79	response to the request (1 data byte)
Error Response	80_h	128	error message

Table 24: Command codes

Bytes 2/3: Parameter index

The parameter index is entered in the user data byte 2 (low byte) and in the user data byte 3 (high byte) using their Intel data format.

Here, the index of the object to be parameterized is entered (see chapter 9.13.2: [Description of objects](#)).

Byte 4: Sub-index

The sub-index indicates the number of the fields for objects realized as an array.

Bytes 5 ... 8: Data area

In the data area, the value of the parameter is entered in left-aligned Intel notation.

Byte 5 = low-Byte ... Byte 8 = high Byte

9.3.7.1 Error code

The actuator sends an error response (byte 1 = 80_h) if a communication error has occurred. An error code is entered in the user data bytes (bytes 5 ... 8). The table below shows the supported error codes.

Command code	Data 1	Data 2	Data 3	Data 4	Meaning
80 _h	11 _h	00 _h	09 _h	06 _h	Sub-Index not exist.
80 _h	02 _h	00 _h	01 _h	06 _h	Attempt to write read only object.
80 _h	01 _h	00 _h	01 _h	06 _h	Attempt to read write only object.
80 _h	30 _h	00 _h	09 _h	06 _h	Value range of parameter exceeded.
80 _h	36 _h	00 _h	09 _h	06 _h	Maximum value is less than minimum value.
80 _h	00 _h	00 _h	02 _h	06 _h	Object does not exist.
80 _h	00 _h	00 _h	01 _h	06 _h	Unsupported access to an object.
80 _h	22 _h	00 _h	00 _h	08 _h	Data cannot be transferred to the application because of the present device state.

Table 25: Error codes

9.3.8 Example: Parameterization

The following 2 examples are intended to illustrate parameterization via Service Data Objects.

9.3.8.1 Example: Read parameter

The actuator has device address 5 and the calibration value is to be read out!

Calculation of the identifier:

Identifier of the parameter channel to the actuator = 600_h + device address

600_h = 1536_{dec}

Identifier = $1536 + 5 = 1541 = 605_h$

Command code = Read request (= request of a parameter from the actuator) = 40_h

Index = $607C_h$

The index of the parameter calibration value was taken from the directory of objects (chapter [9.13.2: Description of objects](#)).

Sub-index = 0

The current calibration value is $2500 = 9C4_h$.

Telegram from the master to the actuator:

Identifier	Byte 1	Byte 2	Byte 3	Byte 4	Byte 5	Byte 6	Byte 7	Byte 8
605_h	40_h	$7C_h$	60_h	00_h	00_h	00_h	00_h	00_h

Response of the actuator:

Identifier	Byte 1	Byte 2	Byte 3	Byte 4	Byte 5	Byte 6	Byte 7	Byte 8
585_h	42_h	$7C_h$	60_h	00_h	$C4_h$	09_h	00_h	00_h

Command code = Read Response = 42_h

Calculation of the identifier:

Identifier of the parameter channel from the actuator to the master = 580_h + device address

$580_h = 1408_{dec}$

Identifier = $1408 + 5 = 1413 = 585_h$

9.3.8.2 Example: Write parameter

For the actuator with device address 5 the limit 1 is to be set to 2000000!

Calculation of the identifier:

Identifier of the parameter channel to the actuator = 600_h + device address

$600_h = 1536_{dec}$

Identifier = $1536 + 5 = 1541 = 605_h$

Command code = Write request (send parameter to the actuator) = 23_h

Index = $607D_h$

Sub-index = 2

The index and the sub-index of the parameter 'limit 1' were taken from the directory of objects (chapter [9.13.2: Description of objects](#)).

$2000000 = 1E8480_h$

Telegram from the master to the actuator:

Identifier	Byte 1	Byte 2	Byte 3	Byte 4	Byte 5	Byte 6	Byte 7	Byte 8
605_h	23_h	$7D_h$	60_h	02_h	80_h	84_h	$1E_h$	00_h

Response of the actuator in the case of error-free execution:

Identifier	Byte 1	Byte 2	Byte 3	Byte 4	Byte 5	Byte 6	Byte 7	Byte 8
585_h	60_h	$7D_h$	60_h	02_h	00_h	00_h	00_h	00_h

Command code = Write Response = 60_h

Calculation of the identifier:

Identifier of the parameter channel from the actuator to the master = 580_h + device address

580_h = 1408_{dec}

Identifier = 1408 + 5 = 1413 = 585_h

9.3.9 Emergency Object (EMCY)

In the case of an error, the node status is transferred via high-priority emergency messages (emergency telegrams). These telegrams have a data length of 8 bytes and contain error information.

The emergency telegram is transferred as soon as the actuator goes into the fault state (for the causes of faults refer to chapter 7.2: Errors) or when a communication error has occurred (see Table 27: Error-Code 8110_h – 8140_h).

Resolution of the cause of fault and resetting of the actuator with undoing the fault state are signalled by sending of an emergency telegram with the error code 0000_h (no error) (not applicable to error code 8140_h).

The cause of the fault is deposited in the fault buffer (see object 1003_h).

Setup of the emergency telegram.

Identifier	Byte 0	Byte 1	Byte 2	Byte 3	Byte 4	Byte 5	Byte 6	Byte 7
11/29 Bit	Emergency Error Code (see chapter 9.3.9)		Error Register (Object 1001 _h)	Manufacturer-specific error field (not used)				

Table 26: Emergency protocol

The identifier of the emergency object is set to 128 + Node-ID by default; however, it can be changed via object 1014_h (see chapter 9.13.2: Description of objects). Transfer of an emergency telegram is enabled in the NMT statuses 'OPERATIONAL' or 'PRE-OPERATIONAL' only!

9.3.9.1 Error Code

The following table contains the possible error codes of the emergency telegram.

Error Code		Meaning
Byte 0 (Highbyte)	Byte 1 (Lowbyte)	
00	00 _h	No error (no fault present) Is sent after clearing the fault state (see chapter 7.2: Errors).
32	11 _h	Control Overvoltage The state machine was set to the 'Fault' state. Fault is deposited in the fault buffer.
32	12 _h	Power Overvoltage The state machine was set to the 'Fault' state. Fault is deposited in the fault buffer.

Error Code		Meaning
Byte 0 (Highbyte)	Byte 1 (Lowbyte)	
32	21 _h	Control Undervoltage The state machine was set to the 'Fault' state. Fault is deposited in the fault buffer.
32	22 _h	Power Undervoltage The state machine was set to the 'Fault' state. Fault is deposited in the fault buffer.
43	10 _h	Overtemperature The state machine was set to the 'Fault' state. Fault is deposited in the fault buffer.
71	21 _h	Motor blocked The state machine was set to the 'Fault' state. Fault is deposited in the fault buffer.
73	00 _h	Sensor SIN/COS monitoring The state machine was set to the 'Fault' state. Fault is deposited in the fault buffer.
81	10 _h	CAN overrun The state machine was set to the 'Fault' state. Fault is deposited in the fault buffer.
81	20 _h	Error Passive
81	40 _h	Recovered from Bus Off
86	11 _h	Contouring Error The state machine was set to the 'Fault' state. Fault is deposited in the fault buffer.
FF	02 _h	Manufacturer specific Error Passive on Move The state machine was set to the 'Fault' state. Fault is deposited in the fault buffer.
FF	03 _h	Manufacturer specific Bus Off
FF	04 _h	Manufacturer specific Timeout Client The state machine was set to the 'Fault' state. Fault is deposited in the fault buffer.
FF	05 _h	Manufacturer specific Timeout Host The state machine was set to the 'Fault' state. Fault is deposited in the fault buffer.
FF	06 _h	Manufacturer specific Checksum Client The state machine was set to the 'Fault' state. Fault is deposited in the fault buffer.
FF	07 _h	Manufacturer specific Checksum Host The state machine was set to the 'Fault' state. Fault is deposited in the fault buffer.

Error Code		Meaning
Byte 0 (Highbyte)	Byte 1 (Lowbyte)	
FF	08 _h	Manufacturer specific Define Mismatch The state machine was set to the 'Fault' state. Fault is deposited in the fault buffer.
FF	09 _h	Manufacturer specific Battery Undervoltage The state machine was set to the 'Fault' state. Fault is deposited in the fault buffer.
FF	0A _h	Manufacturer specific Unknown Bustype The state machine was set to the 'Fault' state. Fault is deposited in the fault buffer.
FF	0B _h	Manufacturer specific Queue 1 overrun The state machine was set to the 'Fault' state. Fault is deposited in the fault buffer.
FF	0C _h	Manufacturer specific Queue 2 overrun The state machine was set to the 'Fault' state. Fault is deposited in the fault buffer.
FF	0D _h	Manufacturer specific Question Answer The state machine was set to the 'Fault' state. Fault is deposited in the fault buffer.
FF	0E _h	Manufacturer specific Checksum EEPROM The state machine was set to the 'Fault' state. Fault is deposited in the fault buffer.
FF	0F _h	Manufacturer specific Queue 3 Overrun The state machine was set to the 'Fault' state. Fault is deposited in the fault buffer.
FF	10 _h	Manufacturer specific Queue 4 Overrun The state machine was set to the 'Fault' state. Fault is deposited in the fault buffer.

Table 27: Error Code

9.3.10 Heartbeat protocol

The master monitors the state of the actuator via heartbeat protocol. While doing this, the actuator sends cyclically its NMT status.

The actuator sends the heartbeat telegram independently, without request via RTR frame. The actuator is a heartbeat producer, it does not receive nor process heartbeat protocols.

The cycle time of the heartbeat telegram is set via object 1017_h (see chapter 9.13.2: [Description of objects](#)).

The heartbeat protocol is deactivated if the cycle time is 0.

The heartbeat protocol consists of one byte.

Identifier	Byte 1
11 Bit	Status

Table 28: Heartbeat protocol

Status = 0: 'INITIALISATION'

Status = 4: 'STOPPED'

Status = 5: 'OPERATIONAL'

Status = 127: 'PRE-OPERATIONAL'

The identifier of the heartbeat protocol is permanently set to 1792 + Node-ID and cannot be changed.

Heartbeat telegram is sent in the NMT statuses 'OPERATIONAL', 'PRE-OPERATIONAL' or 'STOPPED'.

NOTICE	The heartbeat protocol is only enabled when node guarding is deactivated!
---------------	---

9.3.11 Node Guarding

Node-guarding or life-guarding mechanisms are available for failure monitoring of the CANopen network. Via node guarding the nodes are monitored that can detect a failure of the master. During guarding, the master transmits remote frames (remot transmit request, message request telegrams) on the guarding identifiers of the nodes to be monitored. The latter respond with the guarding message containing the current status of the slave as well as a toggle bit which must change after each message.

The master assumes that a node error has occurred if status or toggle bits do not correspond with those expected by the master.

Via the objects 100C_h (Guard Time), 100D_h (Life Time Factor) the time interval (life time) is set within which the actuator expects a node query (RTR frame with the COB-ID 1792 + Node-ID) by the NMT master.

The time interval 'Life time' is calculated from the cycle time 'Guard time' multiplied with the factor 'Life Time Factor'.

The actuator State Machine switches to the 'SWITCH ON DISABLED' state if the actuator receives no RTR frame from the master during the 'Life Time'.

By sending the first RTR frame of the master to the actuator, Node Guarding of the actuator is activated after switching on.

Node Guarding is deactivated if the value of either object (100C_h / 100D_h) is zero.

The response of the actuator to the RTR frame of the master consists of one byte of user data.

Identifier	Byte 1	
11 Bit	Bit 7: Toggle Bit	Bit 6 ... 0: Status

Table 29: Node-Guarding Telegram

Toggle Bit:

The toggle bit must alternate between two subsequent responses of the actuator.

The value of the toggle bit with the first response of the actuator is 0 after activation of the guarding protocol.

Status:

Status = 0: 'INITIALISATION'

Status = 4: 'STOPPED'

Status = 5: 'OPERATIONAL'

Status = 127: 'PRE-OPERATIONAL'

The identifier of the heartbeat protocol is permanently set to 1792 + Node-ID and cannot be changed.

A node guard telegram can be sent in the NMT statuses 'OPERATIONAL', 'PRE-OPERATIONAL' or 'STOPPED'.

NOTICE

The node-guard protocol is only enabled when the heartbeat protocol is deactivated!

9.4 State Machine

In the status word, the CANopen state machine indicates operational and error states of the drive resulting from operational transitions.

The states of the state machine can change via control word (see chapter 9.6: [Control word](#)) or due to internal events (e. g., occurrence of a fault).

The current state of the state machine can be read via the status word (see chapter 9.5: [Status word](#)).

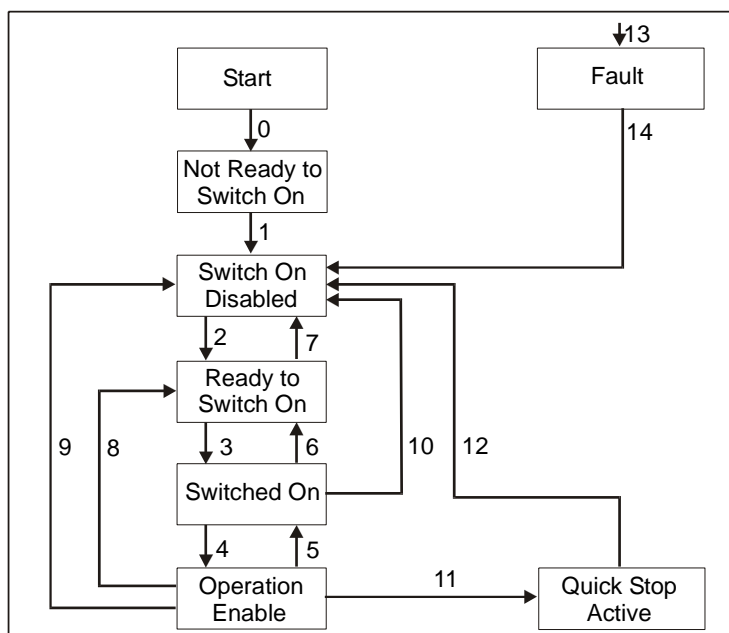

Fig. 10: State machine

The following states of the state machine of the actuator are available:

- 'NOT READY TO SWITCH ON'
The actuator is being initialized after switching on. No travel commands can be accepted. Motor is enabled.
- 'SWITCH ON DISABLED'
Initialization completed. No travel commands can be accepted. Motor is enabled.
- 'READY TO SWITCH ON'
No travel commands can be accepted. Motor is enabled.
- 'SWITCHED ON'
No travel commands can be accepted. Motor is enabled.
- 'OPERATION ENABLED'
Travel commands can be accepted. Motor is in control state.
- 'QUICK STOP ACTIVE'
The Quick Stop command was executed. Motor decelerates with maximum deceleration and stops with stop torque. Current positioning is cancelled. No travel commands can be accepted.
- 'FAULT'
An error has occurred. Motor is enabled. Current positioning is cancelled. No travel commands can be accepted.

The states of the State Machine can be changed via internal events or through commands of the master via control word (see chapter 9.6: [Control word](#)).

- State change 0: START ⇒ NOT READY TO SWITCH ON
Power on or software reset of the actuator.
- State change 1: NOT READY TO SWITCH ON ⇒ SWITCH ON DISABLED
Initialization and self-test of the actuator successfully completed.
- State change 2: SWITCH ON DISABLED ⇒ READY TO SWITCH ON
'Shutdown' command by master.
- State change 3: READY TO SWITCH ON ⇒ SWITCHED ON
'Switch On' command by master.
- State change 4: SWITCHED ON ⇒ OPERATION ENABLE
'Enable Operation' command by master.
- State change 5: OPERATION ENABLE ⇒ SWITCHED ON
'Disable Operation' command by master.
- State change 6: SWITCHED ON ⇒ READY TO SWITCH ON
'Shutdown' command by master.
- State change 7: READY TO SWITCH ON ⇒ SWITCH ON DISABLED
'Disable Voltage' command by master.
- State change 8: OPERATION ENABLE ⇒ READY TO SWITCH ON
'Shutdown' command by master.
- State change 9: OPERATION ENABLE ⇒ SWITCH ON DISABLED
'Disable Voltage' command by master.
- State change 10: SWITCHED ON ⇒ SWITCH ON DISABLED
'Disable Voltage' command by master.

- State change 11: OPERATION ENABLE ⇒ QUICK STOP ACTIVE
'Quick Stop' Befehl vom Master
- State change 12: QUICK STOP ACTIVE ⇒ SWITCH ON DISABLED
'Disable Voltage' command by master.
- State change 13: All states ⇒ FAULT
A fault has occurred.
- State change 14: FAULT ⇒ SWITCH ON DISABLED
'Fault Reset' command by master.

9.5 Status word

The status word reflects the current status of the actuator. It consists of 16 bits and is mapped on object 6041_h and on the 3 Transmit PDOs.

Status word																	
15	14	13	12	11	10	9	8	7	6	5	4	3	2	1	0		
MSB								High Byte				Low Byte				LSB	

Table 30: Status word

The following table lists the designations of the individual bits of the status word and their meanings.

Bit	Designation	Description
0	Ready to switch on	indicates the state of the State Machine (see Table 32)
1	Switched on	indicates the state of the State Machine (see Table 32)
2	Operation enabled	indicates the state of the State Machine (see Table 32)
3	Fault	indicates the state of the State Machine (see Table 32)
4	Voltage enabled	Bit 4 is set when the supply voltage is within the tolerance limit.
5	Quick stop	indicates the state of the State Machine (see Table 32) Bit 5 is set when the actuator is not in the 'QUICK STOP ACTIVE' state.
6	Switch on disabled	indicates the state of the State Machine (see Table 32)
7	Warning	Bit 7 is set when a warning is active (see chapter 7.1: Warnings).
8	Profile Position Mode: show readiness for travel	Bit 8 is set if the State Machine is in the 'OPERATION ENABLED' state und the following conditions are met: - no fault present - Supply voltage of the output stage is applied - no limit have been exceeded - no active travel job
	Profile Velocity Mode: show readiness for travel	Bit 8 is set if the State Machine is in the 'OPERATION ENABLED' state und the following conditions are met: - no fault present - no active travel job - Supply voltage of the output stage is applied

Bit	Designation	Description
9	Remote	Bit 9 is set when the actuator is in the NMT status 'OPERATIONAL' or 'STOPPED'. The actuator receives commands via CAN interface in this case.
10	Profile Position Mode: Target reached	Bit 10 is set when the drive has come to a stop at the pre-defined target position within the defined window after a successfully executed positioning command.
	Profile Velocity Mode: Target reached	Bit 10 is set when the actual speed is within the defined window of the target speed.
11	internal Limit	Bit 11 is set when the upper or lower limits have been exceeded.
12	Profile Position Mode: Set Point Acknowledged	Bit 12 is set when the drive controller has started a travel command in the positioning mode. A travel job is started via bit 'New Setpoint' in the control word (object 6040 _n ; control word bit 4) (value 0 ⇒ 1). Subsequently, the controller firmware plausibilizes the target position, the operation and control parameters and the local state of the drive and sets bit 12 after the check has been passed successfully. Bit 12 is deleted when bit 4 in the control word has been reset to zero following a positioning job (Clear new setpoint).
	Profile Velocity Mode: Speed	Bit 12 is set when the drive stands still.
13	reserved	statically on 0
14	Profile Position Mode: Pos active	Bit 14 is set when there is an active positioning job in the operation mode 'Profile Position Mode' (positioning mode). Notice! No new setpoint is accepted and travelling in inching operation is disabled as long as bit 14 is set!
	Profile Velocity Mode	no meaning, statically on 0
15	Profile Position Mode: drive travels	The drive shaft of the actuator is moving if bit 15 is set.
	Profile Velocity Mode	statically on 0

Table 31: Bit description of the status word

The following table represents the possible states of the state machine and the resulting bit values.

The field containing an x are irrelevant for the states of the state machine.

State	Bit 7	Bit 6	Bit 5	Bit 4	Bit 3	Bit 2	Bit 1	Bit 0
Not Ready to Switch On	x	0	x	x	0	0	0	0
Switch On Disabled	x	1	x	x	0	0	0	0
Ready to Switch On	x	0	1	x	0	0	0	1
Switched On	x	0	1	x	0	0	1	1
Operation Enabled	x	0	1	x	0	1	1	1
Quick Stop Activ	x	0	0	x	0	1	1	1
Fault	x	0	x	x	1	0	0	0

Table 32: Low byte status word States of the state machine

9.6 Control word

The control word consists of 16 bits and is mapped on the object 6040_h, and in the 3 Receive PDOs.

It contains bits for controlling the state machine as well as controlling the operational modes, Profile Position Mode (positioning mode) and Profile Velocity Mode (velocity mode).

Control word															
15	14	13	12	11	10	9	8	7	6	5	4	3	2	1	0
MSB				High Byte				Low Byte				LSB			

Table 33: Control word

The following table lists the designations of the individual bits of the control word and their meanings.

Bit	Designation	Description
0	Switch on	controls the state of the State Machine (see Table 35)
1	Disable voltage	controls the state of the State Machine (see Table 35)
2	Quick stop	controls the state of the State Machine (see Table 35)
3	Enable operation	controls the state of the State Machine (see Table 35)
4	Profile Position Mode: New Setpoint	By bit 4, positioning is triggered in the drive controller in the OPERATION ENABLED state (value 0 ⇒ 1). The drive controller acknowledges the travel command via bit 12 'Setpoint acknowledged' in the status word (see chapter 9.5: Status word).
	Profile Velocity Mode	no meaning
5	reserved	
6	reserved	
7	Fault reset	If the state machine of the actuator is in the FAULT state, the fault is reset by an edge on bit 7 (0 ⇒ 1) and the state machine is set to the SWITCH ON DISABLED state on the condition that the cause of the fault has been resolved in advance (see chapter 7.2: Errors).
8	Profile Position Mode: Stop	By setting bit 8 on value 1, interruption of travel can be triggered during a running positioning event. Motor runs out with programmed deceleration and stops in the control state. Positioning is resumed and completed after resetting the bit (value 1 ⇒ 0).
	Profile Velocity Mode: Stop	By bit 8, drive movement is triggered in the velocity mode in the OPERATION ENABLED state (value 1 ⇒ 0).
9	reserved	
10	reserved	
11	Key enable	Key enable can be controlled via Bit 11 in the OPERATION ENABLED state: 0 = Key enable as defined by object 2400 _h sub-index 08 _h 1 = Key enable inverted as defined by object 2400 _h sub-index 08 _h
12	reserved	

Bit	Designation	Description
13	Profile Position Mode: Inching operation 1	Inching operation 1 is started by an edge change (value 0 ⇒ 1) on bit 13 (see chapter 4.1.3.2: Inching operation).
	Profile Velocity Mode	no meaning
14	Profile Position Mode: Inching operation 2 positive	Inching operation 2 is started in positive travel direction by an edge change (value 0 ⇒ 1) on bit 14 (see chapter 4.1.3.2: Inching operation). The drive travels in positive direction until bit 14 has been deleted.
	Profile Velocity Mode	no meaning
15	Profile Position Mode: Inching operation 2 negative	Inching operation 2 is started in negative travel direction by an edge change (value 0 ⇒ 1) on bit 15 (see chapter 4.1.3.2: Inching operation). The drive travels in negative direction until bit 15 has been deleted.
	Profile Velocity Mode	no meaning

Table 34: Bit description of the control word

The following table shows the control of the state machine with the bit combinations of the control word required.

The fields containing an x are irrelevant for the control of the state machine.

Command	Bit 7	Bit 6	Bit 5	Bit 4	Bit 3	Bit 2	Bit 1	Bit 0
Shutdown	0	x	x	x	x	1	1	0
Switch On	0	x	x	x	0	1	1	1
Disable Voltage	0	x	x	x	x	x	0	x
Quick Stop	0	x	x	x	x	0	1	x
Disable Operation	0	x	x	x	0	1	1	1
Enable Operation	0	x	x	x	1	1	1	1
Fault Reset	0 ⇒ 1	x	x	x	x	x	x	x

Table 35: Low Byte Control word

NOTICE	PDOs are enabled in the NMT status Operational only. Travel commands are enabled in the Operation Enabled state of the state machine.
---------------	--

9.7 Flowchart of the Profile Position Mode (positioning mode)

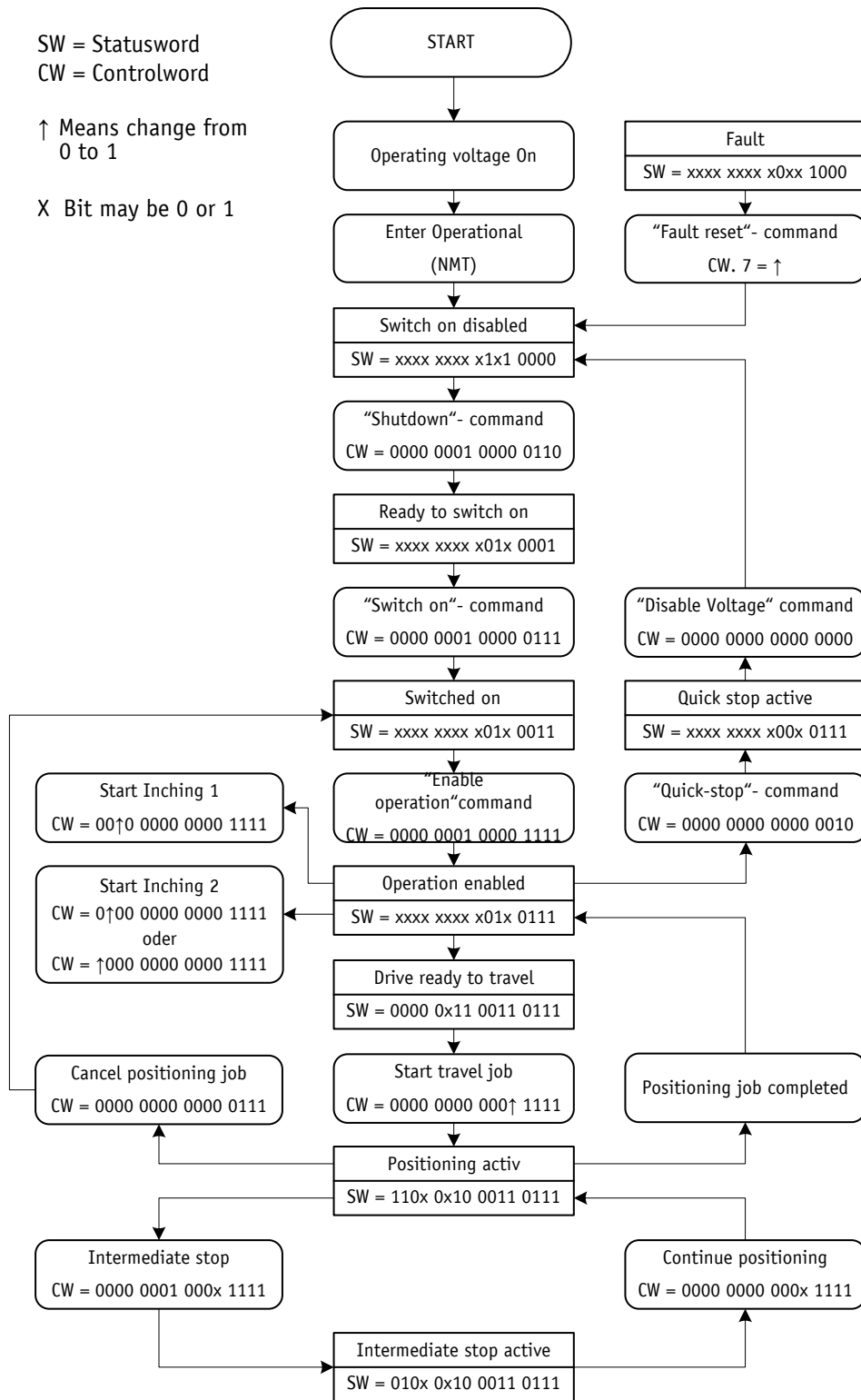

Fig. 11: Flowchart of the Profile Position Mode (positioning mode)

9.8 Flowchart of the Profile Velocity Mode operation mode (velocity mode)

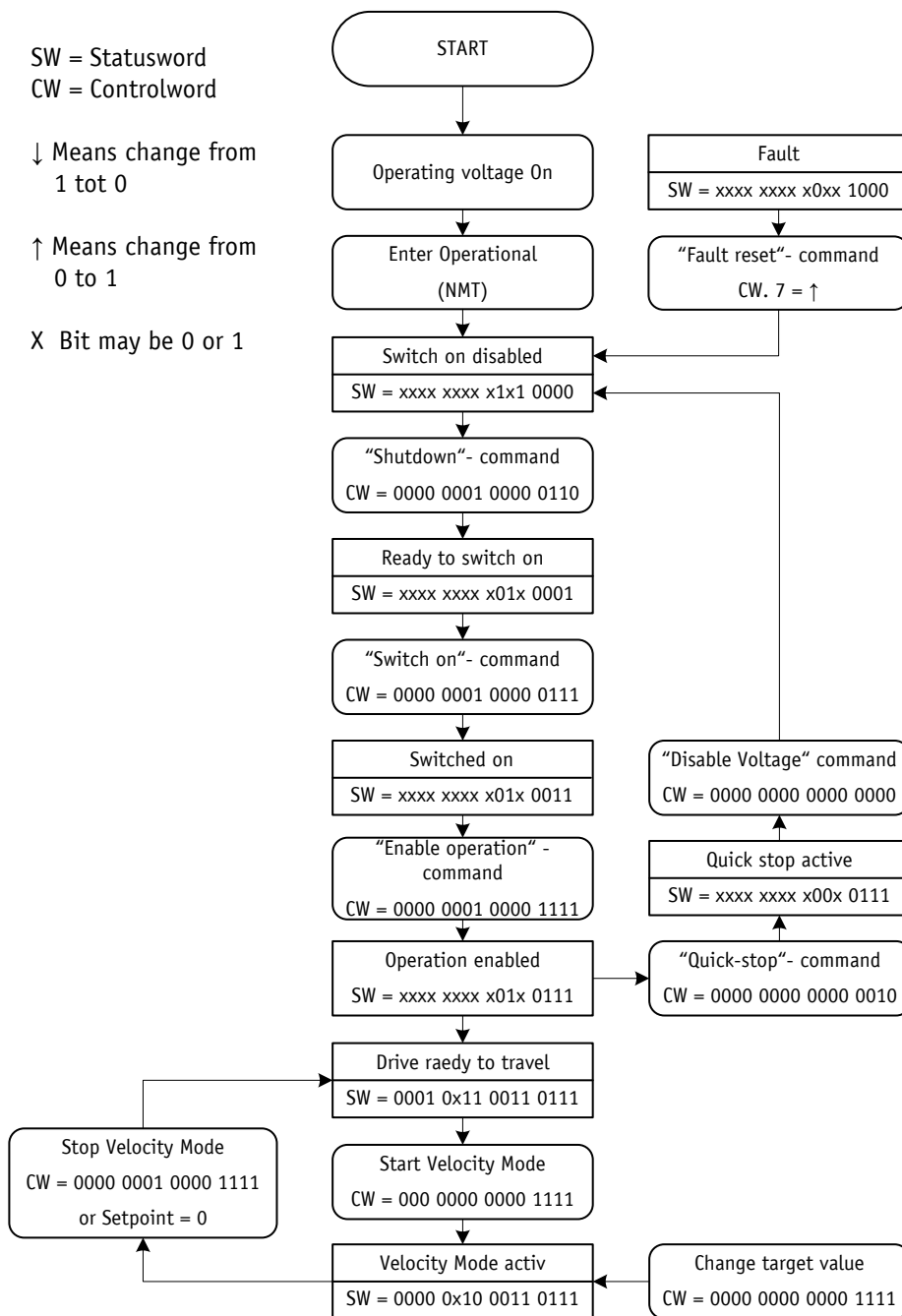

Fig. 12: Flowchart of the Profile Velocity Mode (velocity mode)

9.9 Examples

9.9.1 Example of the Profile Position Mode (positioning mode)

In the following table a positioning example in the Profile Position Mode (positioning mode) is represented.

The node address of the actuator is 5 in this example.

Identifier	Message	Meaning
0x000	0x01 0x05	NMT: Enter OPERATIONAL
0x205	0x06 0x01	RPDO1: Shutdown command
0x205	0x07 0x01	RPDO1: Switch On command
0x205	0x0F 0x01	RPDO1: Enable Operation command
0x405	0x1F 0x00 0x88 0x13 0x00 0x00	RPDO3: Travel to position +5000
-	-	wait until target position has been reached
0x205	0x0F 0x01	RPDO1: clear New Setpoint
0x405	0x1F 0x00 0x78 0xEC 0xFF 0xFF	RPDO3: Travel to position -5000
0x205	0x1F 0x01	RPDO1: Intermediate stop
0x205	0x1F 0x00	RPDO1: continue positioning
-	-	wait until target position has been reached
0x205	0x0F 0x01	RPDO1: clear New Setpoint
0x205	0x07 0x01	RPDO1: Disable Operation command
0x205	0x06 0x01	RPDO1: Shutdown command
0x205	0x00 0x01	RPDO1: Disable Voltage command
0x000	0x80 0x05	NMT: Enter PRE-OPERATIONAL

Table 36: Positioning example in Profile Position Mode

9.9.2 Example of the Profile Velocity Mode (velocity mode)

In the following table an example in the Profile Velocity Mode (velocity mode) is represented. The node address of the actuator is 5 in this example. Operating mode change via parameter 20, see chapter 8: [Parameter description](#) (Default: Profile Position Mode).

Identifier	Message	Meaning
0x000	0x01 0x05	NMT: Enter OPERATIONAL
0x205	0x06 0x01	RPDO1: Shutdown command
0x205	0x07 0x01	RPDO1: Switch On command
0x205	0x0F 0x01	RPDO1: Enable Operation command
0x505	0x0F 0x00 0x0A 0x00 0x00 0x00	RPDO4: Start of velocity mode with the target speed of +10 rev/min positive sense of rotation
-	-	wait until target speed has been reached
0x505	0x0F 0x00 0x05 0x00 0x00 0x00	RPDO4: Change of velocity to +5 rev/min
0x205	0x0F 0x01	RPDO1: Stop drive movement

Identifier	Message	Meaning
0x505	0x0F 0x00 0xF8 0xFF 0xFF 0xFF	RPD04: Start of velocity mode with the target speed of -8 rev/min (negative sense of rotation)
-	-	wait until target speed has been reached
0x205	0x0F 0x01	RPD01: Stop drive movement
0x205	0x07 0x01	RPD01: Disable Operation command
0x205	0x06 0x01	RPD01: Shutdown command
0x205	0x00 0x01	RPD01: Disable Voltage command
0x000	0x80 0x05	NMT: Enter PRE-OPERATIONAL

Table 37: Example of Profile Velocity Mode

9.10 Overview of CANopen identifiers

The following table offers an overview of the identifiers used in the actuator:

Default identifier (hexadecimal)	Default identifier (decimal)	Description	Own setting
0	0	Network management (NMT)	
80	128	SYNC – Message	
80 + Node-ID	128 + Node-ID	Emergency Message	
180 + Node-ID	384 + Node-ID	TPD01	
200 + Node-ID	512 + Node-ID	RPD01	
380 + Node-ID	896 + Node-ID	TPD03	
400 + Node-ID	1024 + Node-ID	RPD03	
480 + Node-ID	1152 + Node-ID	TPD04	
500 + Node-ID	1280 + Node-ID	RPD04	
580 + Node-ID	1408 + Node-ID	SDO (tx)	
600 + Node-ID	1536 + Node-ID	SDO (rx)	
700 + Node-ID	1792 + Node-ID	Heartbeat Message	
700 + Node-ID	1792 + Node-ID	Node-Guard Message	

Table 38: Overview of identifiers

9.11 Setting the CAN baud rate

The CAN baud rate is entered via Object 2100_n (CAN baud rate).

The baud rate is factory-set to 500 kbit/s.

9.12 EDS file

The EDS files (electronic data sheet) are available for the actuator.

This file enables easy integration and configuration of the actuator in a CANopen network using commercial CANopen configurations.

9.13 Directory of objects

Every CANopen device keeps a directory of objects where all parameters of the device are deposited in the form of object entries. The object entries can be accessed via SDO communication services (see chapter 9.3.7: [Service Data Objects \(SDOs\)](#)). Thus, a parameter can be read (SDO upload) and written (SDO download) if permitted by the object entry access rights or the state of the device, respectively.

The following index ranges are used:

1000_h - 1FFF_h objects of the communication profile CIA DS-301 V4.0.

2000_h - 5FFF_h manufacturer-specific object entries.

6000_h - 9FFF_h objects of the device profile CIA DSP-402 V2.0.

9.13.1 Overview of objects

The following table offers an overview of the objects of the actuator.

Index	Name	Description	see page
1000 _h	Device type	The object indicates the device profile number of the actuator.	63
1001 _h	Error register	The object shows error states of the actuator.	64
1002 _h	Manufacturer Status Register	Contains the system status word of the actuator (see chapter 9.2: System Status Word).	64
1003 _h	Pre-Defined Error Field	The object stores up to 10 error messages.	65
1005 _h	COB-ID Sync Message	Setting of the COB ID of the SYNC object.	65
1008 _h	Manufacturer Device Name	Indicates the device name.	66
100A _h	Manufacturer Software Version	Indicates the software version of the controller firmware.	66
100C _h	Guard Time	Setting of the 'Guard Time' for the Node Guarding protocol (see chapter 9.3.11: Node Guarding).	67
100D _h	Life Time Factor	Setting of the time interval 'Life Time' (see chapter 9.3.11: Node Guarding).	67
1011 _h	Restore Default Parameters	Restoration of factory-set states of the changeable parameters and calibration of the actuator (see chapter 5: Calibration).	67
1014 _h	COB-ID Emergency Message	Setting of the COB ID of the Emergency object.	69

Index	Name	Description	see page
1017 _h	Producer Heartbeat Time	Setting of the cycle time for the heartbeat protocol (see chapter 9.3.10: Heartbeat protocol).	70
1018 _h	Identity Objekt	Contains the Vendor ID of the device manufacturer.	70
1200 _h	Server SDO Parameter	Contains the COB IDs of the default server SDO.	72
1400 _h	1 st Receive PDO Parameter	Setting of the communication parameters of the RPDO1.	73
1401 _h	2 nd Receive PDO Parameter	Compatibility entry	75
1402 _h	3 rd Receive PDO Parameter	Setting of the communication parameters of the RPDO3.	76
1403 _h	4 th Receive PDO Parameter	Setting of the communication parameters of the RPDO4.	78
1600 _h	1 st Receive PDO Mapping Parameter	Contains the objects mapped on the RPDO1 (see chapter 9.3.6.1: 1st Receive PDO (RPDO1)).	80
1601 _h	2 nd Receive PDO Mapping Parameter	Compatibility entry	80
1602 _h	3 rd Receive PDO Mapping Parameter	Contains the objects mapped on the RPDO3 (see chapter 9.3.6.2: 3rd Receive PDO (RPDO3)).	81
1603 _h	4 th Receive PDO Mapping Parameter	Contains the objects mapped on the RPDO4 (see chapter 9.3.6.3: 4th Receive PDO (RPDO4)).	82
1800 _h	1 st Transmit PDO Parameter	Setting of the communication parameters of the TPDO1.	83
1801 _h	2 nd Transmit PDO Parameter	Compatibility entry	85
1802 _h	3 rd Transmit PDO Parameter	Setting of the communication parameters of the TPDO3.	86
1803 _h	4 th Transmit PDO Parameter	Setting of the communication parameters of the TPDO4.	88
1A00 _h	1 st Transmit PDO Mapping Parameter	Contains the objects mapped on the TPDO1 (see chapter 9.3.5.1: 1st Transmit PDO (TPDO1)).	91
1A01 _h	2 nd Transmit PDO Mapping Parameter	Compatibility entry	91
1A02 _h	3 rd Transmit PDO Mapping Parameter	Contains the objects mapped on the TPDO3 (see chapter 9.3.5.2: 3rd Transmit PDO (TPDO3)).	92
1A03 _h	4 th Transmit PDO Mapping Parameter	Contains the objects mapped on the TPDO4 (see chapter 9.3.5.3: 4th Transmit PDO (TPDO4)).	93

Index	Name	Description	see page
2001 _h	Manufacturer Offset	Manufacturer-specific offset value (is added internally to the position value).	94
2100 _h	Can-Baud rate	Setting of the CAN baud rate.	94
2101 _h	Node-ID	Setting of the node address.	95
2102 _h	Transfer reduction	Contains the gear reduction.	95
2400 _h	Display and Operation Parameter Set	Configuration of display and operation.	95
2410 _h	Motor Parameter Set	Setting of the control parameters of the drive controller.	99
2412 _h	Spindle Pitch	Setting of the spindle pitch.	102
2413 _h	Pos Type	Setting of the positioning type.	102
2415 _h	Delta Jog	Setting of the travel distance in inching operation 1.	103
2416 _h	Stop Mode Inching Mode 2	Setting of the stop behaviour in inching operation 2.	103
2417 _h	Inpos Mode	Setting of the behaviour upon reaching the positioning window.	103
2418 _h	Loop Length	Setting the loop length.	104
2419 _h	Contouring Error Limit	Setting the contouring error limit.	104
241A _h	Contouring Error	Current contouring error	104
241B _h	Power Supply Voltage	Voltage supply of output stage and control.	105
241C _h	Output Stage Temperature	Output stage temperature.	105
241E _h	Motor Current	Actual motor current	106
2421 _h	Motor Current Limit	Setting of motor current limitation.	106
2423 _h	Battery Voltage	Actual battery voltage	106
2450 _h	Inching 2 Offset	Offset value in inching operation 2.	107
2451 _h	Type of acceleration Inching Mode 2	Type of acceleration in inching operation 2.	107
2500 _h	Production Date	Contains the drive's production date.	107
2501 _h	Display Software Version	Indicates the software version of the display controller firmware.	108
6040 _h	Controlword	Contains the control word of the state machine for drives.	108
6041 _h	Statusword	Contains the status word of the state machine for drives.	109
6060 _h	Modes of Operation	Setting of the operation mode: Profile Position Mode / Profile Velocity Mode.	109
6061 _h	Modes of Operation Display	Operating mode set.	110

Index	Name	Description	see page
6064 _h	Position Actual Value	Contains the absolute actual position in the operation mode Profile Position Mode (positioning mode).	110
6067 _h	Position Window	Setting of the tolerance window.	111
606C _h	Velocity Actual Value	Contains the actual velocity in the operation mode Profile Velocity Mode (velocity mode).	111
607A _h	Target Position	Contains the target position in the operation mode Profile Position Mode (positioning mode).	111
607C _h	Calibration Value	Calibration	112
607D _h	Software Position Limit	Setting of the limits.	112
607E _h	Polarity	Setting of the polarity.	113
6091 _h	Gear Ratio	Setting of gear ratio.	113
60FF _h	Target Velocity	Contains the target velocity in the operation mode Profile Velocity Mode (velocity mode).	114

Table 39: Overview of objects

9.13.2 Description of objects

Below, all objects of the actuator are described sorted by their indexes.

9.13.2.1 1000_h: Device Type

Object 1000_h indicates the device profile number.

Sub-index	00 _h
Description	Information on the device profile
Access	read-only
PDO mapping	no
Data type	Unsigned32
Default	00000192 _h
EEPROM	no

Format description:

Bit 31 - 24	Manufacturer-specific (not used)
Bit 23 - 16	drive type (not used)
Bit 15 - 0	device profile number

9.13.2.2 1001_h: Error Register

Object 1001_h indicates the error state of the device.

Sub-index	00 _h
Description	current error code
Access	read-only
PDO mapping	no
Data type	Unsigned8
Default	no
EEPROM	no

Format description:

Bit 7	Manufacturer-specific error
Bit 6	reserved (statically 0)
Bit 5	Drive shaft blocked
Bit 4	Error during data transfer
Bit 3	Temperature
Bit 2	Voltage
Bit 1	Current
Bit 0	General error (is set when error is present)

A detailed error evaluation can be attained via object 1003_h (Predefined Error Field). Faults and errors are signalled at the time of their occurrence by an emergency message (see chapter [9.3.9: Emergency Object \(EMCY\)](#)).

9.13.2.3 1002_h: Manufacturer Status Register

Object 1002_h indicates the system status word of the actuator (see chapter [9.2: System Status Word](#)).

Sub-index	00 _h
Description	Manufacturer-specific status register
Access	read-only
PDO mapping	no
Data type	Unsigned32
Default	no
EEPROM	no

Format description:

Bit 31 - 16	not used
Bit 15 - 0	see chapter 9.2: System Status Word

9.13.2.4 1003_h: Pre-defined Error Field

Object 1003_h stores the last 10 causes of faults.

The entry under sub-index 00_h contains the number of faults currently stored.

The latest fault message is stored under sub-index 01_h.

Writing a '0' on sub-index 00_h resets the fault buffer.

Sub-index	00 _h
Description	number of fault messages
Access	read-write (recordable in the "Pre-Operational" and "Operational" states, cannot be written with active travel job)
PDO mapping	no
Data type	Unsigned8
Default	0
EEPROM	no
Value range	0 ... 10

Sub-index	01 _h ... 0A _h
Description	faults that occurred
Access	read-only
PDO mapping	no
Data type	Unsigned32
Default	no
EEPROM	yes

Format description:

Bit 31 - 16	not used
Bit 15 - 8	error code high byte (see chapter 9.3.9.1: Error Code)
Bit 7 - 0	error code low byte (see chapter 9.3.9.1: Error Code)

9.13.2.5 1005_h: COB-ID Sync Message

The COB-ID of the SYNC object is set via object 1005_h.

The SYNC message is sent to all network participants (broadcast object).

Sub-index	00 _h
Description	COB-ID SYNC message (recordable in the "Pre-Operational" state)
Access	read-write
PDO mapping	no
Data type	Unsigned32
Default	80 _h
EEPROM	no

Format description:

Bit 31 - 30	not used
Bit 29	0 = 11-bit identifier (CAN 2.0A) 1 = 29-bit identifier (CAN 2.0B)
Bit 28 - 11	if bit 29=1, Bit 28 ... 11 des 29-bit identifier
Bit 10 - 0	bit 10 ... 0 of the identifier

9.13.2.6 1008_h: Manufacturer Device Name

Object 1008_h indicates the device name.

Sub-index	00 _h
Description	Device name in ASCII characters
Access	const
PDO mapping	no
Data type	Visible String
Default	no
EEPROM	no

Format description (example):

Bit 7 - 0	41 _h = ' A ' (ASCII character, ISO 8859)
Bit 15 - 8	47 _h = ' G ' (ASCII character, ISO 8859)
Bit 23 - 16	30 _h = ' 0 ' (ASCII character, ISO 8859)
Bit 31 - 24	36 _h = ' 6 ' (ASCII character, ISO 8859)

Device name = AG06

9.13.2.7 100A_h: Manufacturer Software Version

Object 100A_h indicates the software version of the controller firmware.

Sub-index	00 _h
Description	Software version as ASCII characters
Access	const
PDO mapping	no
Data type	Visible String
Default	no
EEPROM	no

Format description (example):

Bit 7 - 0	31 _h = ' 1 ' (ASCII character, ISO 8859)
Bit 15 - 8	2E _h = ' . ' (ASCII character, ISO 8859)
Bit 23 - 16	30 _h = ' 0 ' (ASCII character, ISO 8859)
Bit 31 - 24	30 _h = ' 0 ' (ASCII character, ISO 8859)

Software version = V 1.00

9.13.2.8 100C_n: Guard Time

The cycle time 'Guard Time' for node guarding is set via object 100C_n. The cycle time 'Guard Time' is given in milliseconds (see chapter 9.3.11: [Node Guarding](#)).

Sub-index	00 _h
Description	Guard Time
Access	read-write (recordable in the "Pre-Operational" and "Operational" states)
PDO mapping	no
Unit	milliseconds
Data type	Unsigned16
Default	no
EEPROM	no

Data description:

Value '0' means that node guarding is deactivated.

9.13.2.9 100D_n: Life Time Factor

The time interval 'Life Time' for life guarding is set via object 100D_n (see chapter 9.3.11: [Node Guarding](#)).

Sub-index	00 _h
Description	Life Time Faktor (recordable in the "Pre-Operational" and "Operational" states)
Access	read-write
PDO mapping	no
Data type	Unsigned8
Default	0
EEPROM	no

Data description:

Value '0' means that Life Guarding is deactivated.

9.13.2.10 1011_n: Restore Default Parameters

The default values of the changeable parameters can be retrieved via object 1011_n.

Parameter ranges are specified by selecting the respective subindex:

Sub-index 01_h: set all parameters to default values

Sub-index 04_h: set only standard parameters to default values

Sub-index 05_h: set only control parameters to default values

Sub-index 06_h: calibrate the actuator

Sub-index 07_h: set only display parameter to default

Sub-index	00 _h
Description	Number of subindexes
Access	read-only
PDO mapping	no
Data type	Unsigned8
Default	5
EEPROM	no

Sub-index	01 _h
Description	set all parameters to default values
Access	read-write (recordable in the "Pre-Operational" and "Operational" states, cannot be written with active travel job)
PDO mapping	no
Data type	Unsigned32
Default	no
EEPROM	no

Sub-index	04 _h
Description	set standard parameters to default values
Access	read-write (recordable in the "Pre-Operational" and "Operational" states, cannot be written with active travel job)
PDO mapping	no
Data type	Unsigned32
Default	no
EEPROM	no

Sub-index	05 _h
Description	set controller parameters to default values
Access	read-write (recordable in the "Pre-Operational" and "Operational" states, cannot be written with active travel job)
PDO mapping	no
Data type	Unsigned32
Default	no
EEPROM	no

Sub-index	06 _h
Description	calibrate the actuator
Access	read-write (recordable in the "Pre-Operational" and "Operational" states, cannot be written with active travel job)
PDO mapping	no
Data type	Unsigned32
Default	no
EEPROM	no

Sub-index	07 _h
Description	Set display parameter to default
Access	read-write (recordable in the "Pre-Operational" and "Operational" states, cannot be written with active travel job)
PDO mapping	no
Data type	Unsigned32
Default	no
EEPROM	no

Format description sub-index 01_h, 04_h – 07_h:

Bit 31 - 24	64 _h = ' d ' (ASCII character, ISO 8859)
Bit 23 - 16	61 _h = ' a ' (ASCII character, ISO 8859)
Bit 15 - 8	6F _h = ' o ' (ASCII character, ISO 8859)
Bit 7 - 0	6C _h = ' l ' (ASCII character, ISO 8859)

By writing the signature 'load' to a sub-index 01, 04 ... 07, the factory settings (see chapter 8: [Parameter description](#) ⇒ Default column) of the respective parameters are retrieved. By writing the signature 'load' to sub-index 06, the actuator is calibrated (see chapter 5: [Calibration](#)).

9.13.2.11 1014_h: COB-ID Emergency Message

The COB-ID of the Emergency object is set via object 1014_h (see chapter 9.3.9: [Emergency Object \(EMCY\)](#)).

Sub-index	00 _h
Description	COB-ID der Emergency-Message
Access	read-write (recordable in the "Pre-Operational" state)
PDO mapping	no
Data type	Unsigned32
Default	80 _h + Node-ID
EEPROM	no

Format description:

Bit 31	0 = EMCY exists / is valid 1 = EMCY does not exist / is not valid
Bit 30	reserved (always 0)
Bit 29	0 = 11-bit identifier (CAN 2.0A) 1 = 29-bit identifier (CAN 2.0B)
Bit 28 - 11	if bit 29=1, bit 28 ... 11 of the 29-bit identifier
Bit 10 - 0	bit 10 ... 0 of the identifier

9.13.2.12 1017_h: Producer Heartbeat Time

The cycle time 'Heartbeat Time' for the heartbeat protocol is set via object 1017_h. The 'Heartbeat Time' is given in milliseconds (see chapter [9.3.10: Heartbeat protocol](#)).

Sub-index	00 _h
Description	Producer Heartbeat Time
Access	read-write (recordable in the "Pre-Operational" and "Operational" states)
PDO mapping	no
Unit	milliseconds
Data type	Unsigned16
Default	0
EEPROM	no

Data description:

Value '0' means that the heartbeat protocol is deactivated.

9.13.2.13 1018_h: Identity Object

The Vendor ID of the manufacturer is indicated via object 1018_h.

Sub-index	00 _h
Description	Number of subindexes
Access	read-only
PDO mapping	no
Data type	Unsigned8
Default	4
EEPROM	no

Sub-index	01 _h
Description	Vendor - ID
Access	read-only
PDO mapping	no
Data type	Unsigned32
Default	195 _h (SIKO GmbH)
EEPROM	no

Sub-index	02 _h
Description	Product Code (no function: Compatibility entry)
Access	read-only
PDO mapping	no
Data type	Unsigned32
Default	0
EEPROM	no

Sub-index	03 _h
Description	Revision Number (no function: Compatibility entry)
Access	read-only
PDO mapping	no
Data type	Unsigned32
Default	0
EEPROM	no

Sub-index	04 _h
Description	Serial Number
Access	read-only
PDO mapping	no
Data type	Unsigned32
Default	no
EEPROM	no

Vendor-ID:

The Vendor ID is assigned by the CAN user organization CiA e. V. (CAN in Automation).

Vendor ID '195_h' has been assigned to the company SIKO GmbH.

9.13.2.14 1200_h: Server SDO Parameter

The COB IDs for the Default Server SDO are indicated via object 1200_h (see chapter 9.3.7: [Service Data Objects \(SDOs\)](#)).

Sub-index	00 _h
Description	Number of subindexes
Access	read-only
PDO mapping	no
Data type	Unsigned8
Default	2
EEPROM	no

Sub-index	01 _h
Description	COB-ID Master ⇒ actuator (rx)
Access	read-only
PDO mapping	no
Data type	Unsigned32
Default	600 _h + Node-ID
EEPROM	no

Sub-index	02 _h
Description	COB-ID Stellantrieb ⇒ Master (tx)
Access	read-only
PDO mapping	no
Data type	Unsigned32
Default	580 _h + Node-ID
EEPROM	no

Format description:

Bit 31	0 = SDO valid 1 = SDO not valid
Bit 30	reserved (statically 0)
Bit 29	0 = 11-bit identifier (CAN 2.0A) 1 = 29-bit identifier (CAN 2.0B)
Bit 28 - 11	if bit 29=1, bit 28 ... 11 of the 29-bit identifier
Bit 10 - 7	4 bit function code of the identifier
Bit 6 - 0	7 bit Node ID of the identifier

Data description:

The default DSO cannot be changed (according to the CiA DS-301 Predefined Connection Set).

9.13.2.15 1400_h: 1st Receive PDO Parameter

Durch das Objekt 1400_h werden die Kommunikationsparameter des ersten Receive-PDOs (RPDO1) eingestellt.

Sub-index	00 _h
Description	largest sub-index supported
Access	read-only
PDO mapping	no
Data type	Unsigned8
Default	5
EEPROM	no

Sub-index	01 _h
Description	COB-ID
Access	read-write (recordable in the "Pre-Operational" state)
PDO mapping	no
Data type	Unsigned32
Default	200 _h + Node-ID
EEPROM	no

Sub-index	02 _h
Description	Transfer type (see chapter 9.3.6.4: Transfer types of the Receive PDOs)
Access	read-write (recordable in the "Pre-Operational" state)
PDO mapping	no
Data type	Unsigned8
Default	255
EEPROM	no

Sub-index	03 _h
Description	Inhibit Time (no function: Compatibility entry)
Access	read
PDO mapping	no
Data type	Unsigned16
Default	0
EEPROM	no

Sub-index	05 _n
Description	Event Timer (no function: Compatibility entry)
Access	read
PDO mapping	no
Data type	Unsigned16
Default	0
EEPROM	no

Format description sub-index 01_n:

Bit 31	0 = PDO exists / is valid 1 = PDO does not exist / is not valid
Bit 30	not used
Bit 29	0 = 11-bit identifier (CAN 2.0A) 1 = 29-bit identifier (CAN 2.0B)
Bit 28 - 11	if bit 29=1, bit 28 ... 11 of the 29-bit identifier
Bit 10 - 7	4 bit function code of the identifier
Bit 6 - 0	7 bit Node ID of the identifier

Data description sub-index 02_n:

0	synchronous: RPDO1 is processed only after a SYNC message has been received
1 ... 240	synchronous: identical with value 0
241 ... 251	reserved
252	reserved
253	reserved
254	identical with value 255
255	asynchronous: RPDO1 is immediately processed

PDO mapping:

See object 1600_n (1st receive PDO mapping parameter).

Processing of PDOs:

Receive PDOs are processed in the NMT status 'OPERATIONAL' only. It is not recommended to change the transfer type of the RPDO1 since otherwise the functioning of the state machine would no longer be ensured.

Changing PDO parameters:

PDO parameters can be changed in the NMT status 'PRE-OPERATIONAL' only.

9.13.2.16 1401_h: 2nd Receive PDO Parameter

Object 1401_h was implemented for compatibility reasons only and has no function.

Sub-index	00 _h
Description	largest sub-index supported
Access	read-only
PDO mapping	no
Data type	Unsigned8
Default	5
EEPROM	no

Sub-index	01 _h
Description	COB-ID (no function: Compatibility entry)
Access	read-only
PDO mapping	no
Data type	Unsigned32
Default	301 _h
EEPROM	no

Sub-index	02 _h
Description	Transfer type (no function: Compatibility entry)
Access	read-only
PDO mapping	no
Data type	Unsigned8
Default	255
EEPROM	no

Sub-index	03 _h
Description	Inhibit Time (no function: Compatibility entry)
Access	read-only
PDO mapping	no
Data type	Unsigned16
Default	0
EEPROM	no

Sub-index	05 _h
Description	Event Timer (no function: Compatibility entry)
Access	read-only
PDO mapping	no
Data type	Unsigned16
Default	0
EEPROM	no

9.13.2.17 1402_h: 3rd Receive PDO Parameter

The communication parameters of the third Receive PDO (RPD03) are set via object 1402_h.

Sub-index	00 _h
Description	largest sub-index supported
Access	read-only
PDO mapping	no
Data type	Unsigned8
Default	5
EEPROM	no

Sub-index	01 _h
Description	COB-ID
Access	read-write (recordable in the "Pre-Operational" state)
PDO mapping	no
Data type	Unsigned32
Default	400 _h + Node-ID
EEPROM	no

Sub-index	02 _h
Description	Transfer type (see chapter 9.3.6.4: Transfer types of the Receive PDOs)
Access	read-write (recordable in the "Pre-Operational" state)
PDO mapping	no
Data type	Unsigned8
Default	255
EEPROM	no

Sub-index	03 _n
Description	Inhibit Time (no function: Compatibility entry)
Access	read
PDO mapping	no
Data type	Unsigned16
Default	0
EEPROM	no

Sub-index	05 _n
Description	Event Timer (no function: Compatibility entry)
Access	read
PDO mapping	no
Data type	Unsigned16
Default	0
EEPROM	no

Format description sub-index 01_n:

Bit 31	0 = PDO exists / is valid 1 = PDO does not exist / is not valid
Bit 30	not used
Bit 29	0 = 11-bit identifier (CAN 2.0A) 1 = 29-bit identifier (CAN 2.0B)
Bit 28 - 11	if bit 29=1, bit 28 ... 11 of the 29-bit identifier
Bit 10 - 7	4 bit function code of the identifier
Bit 6 - 0	7 bit Node ID of the identifier

Data description sub-index 02_n:

0	synchronous: RPDO1 is processed only after a SYNC message has been received
1 ... 240	synchronous: identical with value 0
241 ... 251	reserved
252	reserved
253	reserved
254	identical with value 255
255	asynchronous: RPDO1 is immediately processed

PDO mapping:

See object 1602_n (3rd receive PDO mapping parameter).

Processing of PDOs:

Receive PDOs are processed in the NMT status 'OPERATIONAL' only.

Changing PDO parameters:

PDO parameters can be changed in the NMT status 'PRE-OPERATIONAL' only.

9.13.2.18 1403_h: 4th Receive PDO Parameter

The communication parameters of the fourth Receive PDO (RPD04) are set via object 1403_h.

Sub-index	00 _h
Description	largest sub-index supported
Access	read-only
PDO mapping	no
Data type	Unsigned8
Default	5
EEPROM	no

Sub-index	01 _h
Description	COB-ID
Access	read-write (recordable in the "Pre-Operational" state)
PDO mapping	no
Data type	Unsigned32
Default	500 _h + Node-ID
EEPROM	no

Sub-index	02 _h
Description	Transfer type (see chapter 9.3.6.4: Transfer types of the Receive PDOs)
Access	read-write (recordable in the "Pre-Operational" state)
PDO mapping	no
Data type	Unsigned8
Default	255
EEPROM	no

Sub-index	03 _h
Description	Inhibit Time (no function: Compatibility entry)
Access	read
PDO mapping	no
Data type	Unsigned16
Default	0
EEPROM	no

Sub-index	05 _h
Description	Event Timer (no function: Compatibility entry)
Access	read
PDO mapping	no
Data type	Unsigned16
Default	0
EEPROM	no

Format description sub-index 01_h:

Bit 31	0 = PDO exists / is valid 1 = PDO does not exist / is not valid
Bit 30	not used
Bit 29	0 = 11-bit identifier (CAN 2.0A) 1 = 29-bit identifier (CAN 2.0B)
Bit 28 - 11	if bit 29=1, bit 28 ... 11 of the 29-bit identifier
Bit 10 - 7	4 bit function code of the identifier
Bit 6 - 0	7 bit Node ID of the identifier

Data description sub-index 02_h:

0	synchronous: RPDO1 is processed only after a SYNC message has been received
1 ... 240	synchronous: identical with value 0
241 ... 251	reserved
252	reserved
253	reserved
254	identical with value 255
255	asynchronous: RPDO1 is immediately processed

PDO mapping:

See object 1603_h (4th receive PDO mapping parameter).

Processing of PDOs:

Receive PDOs are processed in the NMT status 'OPERATIONAL' only.

Changing PDO parameters:

PDO parameters can be changed in the NMT status 'PRE-OPERATIONAL' only.

9.13.2.19 1600_h: 1st Receive PDO Mapping Parameter

Object 1600_h determines the objects that are mapped on the first Receive PDO (RPDO1).

Sub-index	00 _h
Description	Number of mapped application objects in RPDO 1
Access	read-only
PDO mapping	no
Data type	Unsigned8
Default	1
EEPROM	no

Sub-index	01 _h
Description	first object mapped
Access	read-only
PDO mapping	no
Data type	Unsigned32
Default	60400010 _h
EEPROM	no

Format description sub-index 01_h:

Bit 31 - 16	Index 16 bits
Bit 15 - 8	Sub-index 8 bits
Bit 7 - 0	8 bits object length

Data description:

The object cannot be changed (static mapping).

Mapped objects:

- Object 6040_h (control word) in bytes 0 and 1.

9.13.2.20 1601_h: 2nd Receive PDO Mapping Parameter

Object 1601_h was implemented for compatibility reasons only and has no function.

Sub-index	00 _h
Description	Number of mapped application objects in RPDO 2
Access	read-only
PDO mapping	no
Data type	Unsigned8
Default	0
EEPROM	no

9.13.2.21 1602_h: 3rd Receive PDO Mapping Parameter

Object 1602_h determines the objects that are mapped on the third Receive PDO (RPDO3).

Sub-index	00 _h
Description	Number of mapped application objects in RPDO 3
Access	read-only
PDO mapping	no
Data type	Unsigned8
Default	2
EEPROM	no

Sub-index	01 _h
Description	first object mapped
Access	read-only
PDO mapping	no
Data type	Unsigned32
Default	60400010 _h
EEPROM	no

Sub-index	02 _h
Description	second object mapped
Access	read-only
PDO mapping	no
Data type	Unsigned32
Default	607A0020 _h
EEPROM	no

Format description sub-index 01_h – 02_h:

Bit 31 - 16	index 16 bits
Bit 15 - 8	sub-index 8 bits
Bit 7 - 0	8 bits object length

Data Description:

The object cannot be changed (static mapping).

Mapped objects:

- Object 6040_h (control word) in bytes 0 and 1.
- Object 607A_h (target position) in bytes 2 to 5.

9.13.2.22 1603_h: 4th Receive PDO Mapping Parameter

Object 1603_h determines the objects that are mapped on the fourth Receive PDO (RPDO4).

Sub-index	00 _h
Description	Number of mapped application objects in RPDO 4
Access	read-only
PDO mapping	no
Data type	Unsigned8
Default	2
EEPROM	no

Sub-index	01 _h
Description	first object mapped
Access	read-only
PDO mapping	no
Data type	Unsigned32
Default	60400010 _h
EEPROM	no

Sub-index	02 _h
Description	second object mapped
Access	read-only
PDO mapping	no
Data type	Unsigned32
Default	60FF0020 _h
EEPROM	no

Format description sub-index 01_h – 02_h:

Bit 31 - 16	index 16 bits
Bit 15 - 8	sub-index 8 bits
Bit 7 - 0	8 bits object length

Data description:

The object cannot be changed (static mapping).

Mapped objects:

- Object 6040_h (control word) in bytes 0 and 1.
- Object 60FF_h (target velocity) in bytes 2 to 5.

9.13.2.23 1800_h: 1st Transmit PDO Parameter

The communication parameters of the first Transmit PDO (TPD01) are set via object 1800_h.

Sub-index	00 _h
Description	largest sub-index supported
Access	read-only
PDO mapping	no
Data type	Unsigned8
Default	5
EEPROM	no

Sub-index	01 _h
Description	COB-ID
Access	read-write (recordable in the "Pre-Operational" state)
PDO mapping	no
Data type	Unsigned32
Default	180 _h + Node-ID
EEPROM	no

Sub-index	02 _h
Description	Transfer type (see chapter 9.3.6.4: Transfer types of the Receive PDOs)
Access	read-write (recordable in the "Pre-Operational" state)
PDO mapping	no
Data type	Unsigned8
Default	255
EEPROM	no

Sub-index	03 _h
Description	Inhibit Time
Access	read-write (recordable in the "Pre-Operational" state)
PDO mapping	no
Unit	x 100 μs
Data type	Unsigned16
Default	100
EEPROM	no

Sub-index	05 _h
Description	Event Timer
Access	read-write (recordable in the "Pre-Operational" state)
PDO mapping	no
Unit	milliseconds
Data type	Unsigned16
Default	0
EEPROM	no
Value range	0 ... 65535 The service is switched off by writing the value 0.

Format description sub-index 01_h:

Bit 31	0 = PDO exists / is valid 1 = PDO does not exist / is not valid
Bit 30	0 = request via RTR frame enabled 1 = request via RTR frame disabled
Bit 29	0 = 11-bit identifier (CAN 2.0A) 1 = 29-bit identifier (CAN 2.0B)
Bit 28 - 11	if bit 29=1, bit 28 ... 11 of the 29-bit identifier
Bit 10 - 7	4 bit function code of the identifier
Bit 6 - 0	7 bit Node-ID of the identifier

Data description sub-index 02_h:

0	synchronous: acyclic, PDO is sent after each SYNC message.
1 ... 240	synchronous: cyclic, PDO is sent after 1 ... 240 SYNC messages received.
241 ... 251	reserved
252	reserved
253	asynchronous: only on request (RTR frame). PDO is sent immediately after receipt of the RTR frame. Notice! Must have been enabled via bit 30 of sub-index 1.
254	asynchronous: Event-triggered (with every change of a mapped object and time-controlled)
255	asynchronous: time-triggered

PDO mapping:

See object 1A00_h (1st transmit PDO mapping parameter).

Inhibit Time:

A send-inhibit time is specified by the 'Inhibit Time' parameter (only for transmitt type 254). Resolution is a multiple of 100 µs. The actual send-inhibit time is inaccurate and can deviate from the set value by several milliseconds.

Event Timer:

The 'Event Timer' parameter serves for setting a cycle time (in milliseconds) for time-triggered transfer of the Transmit PDO1. The actual cycle time is inaccurate and can deviate from the set value by several milliseconds.

Processing of PDOs:

Transmit PDOs are transferred in the NMT status 'OPERATIONAL' only.

It is not recommended to change the transfer type of the TPDO1 since otherwise the functioning of the state machine would no longer be ensured.

Changing PDO parameters:

PDO parameters can be changed in the NMT status 'PRE-OPERATIONAL' only.

9.13.2.24 1801_n: 2nd Transmit PDO Parameter

Object 1801_n was implemented for compatibility reasons only and has no function.

Sub-index	00 _n
Description	largest sub-index supported
Access	read-only
PDO mapping	no
Data type	Unsigned8
Default	5
EEPROM	no

Sub-index	01 _n
Description	COB-ID
Access	read-only
PDO mapping	no
Data type	Unsigned32
Default	281 _n
EEPROM	no

Sub-index	02 _n
Description	Transmission type (no function: Compatibility entry)
Access	read-only
PDO mapping	no
Data type	Unsigned8
Default	255
EEPROM	no

Sub-index	03 _h
Description	Inhibit Time (no function: Compatibility entry)
Access	read-only
PDO mapping	no
Data type	Unsigned16
Default	0
EEPROM	no

Sub-index	05 _h
Description	Event Timer (no function: Compatibility entry)
Access	read-only
PDO mapping	no
Unit	milliseconds
Data type	Unsigned16
Default	0
EEPROM	no

9.13.2.25 1802_h: 3rd Transmit PDO Parameter

The communication parameters of the third Transmit PDO (TPDO3) are set via object 1802_h (TPDO3) eingestellt.

Sub-index	00 _h
Description	largest sub-index supported
Access	read-only
PDO mapping	no
Data type	Unsigned8
Default	5
EEPROM	no

Sub-index	01 _h
Description	COB-ID
Access	read-write (recordable in the "Pre-Operational" state)
PDO mapping	no
Data type	Unsigned32
Default	380 _h + Node-ID
EEPROM	no

Sub-index	02 _h
Description	Transfer type (see chapter 9.3.5.4: Transfer types of the Transmit PDOs)
Access	read-write (recordable in the "Pre-Operational" state)
PDO mapping	no
Data type	Unsigned8
Default	253
EEPROM	no

Sub-index	03 _h
Description	Inhibit Time
Access	read-write (recordable in the "Pre-Operational" state)
PDO mapping	no
Unit	x 100 μ s
Data type	Unsigned16
Default	100
EEPROM	no

Sub-index	05 _h
Description	Event Timer
Access	read-write (recordable in the "Pre-Operational" state)
PDO mapping	no
Unit	milliseconds
Data type	Unsigned16
Default	0
EEPROM	no
Value range	0 ... 65535 The service is switched off by writing the value 0.

Format description sub-index 01_h:

Bit 31	0 = PDO exists / is valid 1 = PDO does not exist / is not valid
Bit 30	0 = request via RTR frame enabled 1 = request via RTR frame disabled
Bit 29	0 = 11-bit identifier (CAN 2.0A) 1 = 29-bit identifier (CAN 2.0B)
Bit 28 - 11	if bit 29=1, bit 28 ... 11 of the 29-bit identifier
Bit 10 - 7	4 bit function code of the identifier
Bit 6 - 0	7 bit Node-ID of the identifier

Data description sub-index 02_h:

0	synchronous: acyclic, PDO is sent after each SYNC message.
1 ... 240	synchronous: cyclic, PDO is sent after 1 ... 240 SYNC messages received.
241 ... 251	reserved
252	reserved
253	asynchronous: only on request (RTR frame). PDO is sent immediately after receipt of the RTR frame. Notice! Must have been enabled via bit 30 of sub-index 1.
254	asynchronous: Event-triggered (with every change of a mapped object and time-controlled).
255	asynchronous: time-triggered

PDO mapping:

See object 1A02_h (3rd transmit PDO mapping parameter).

Inhibit Time:

A send-inhibit time is specified by the 'Inhibit Time' parameter (only for transmit type 254). Resolution is a multiple of 100 µs. The actual send-inhibit time is inaccurate and can deviate from the set value by several milliseconds.

Event Timer:

The 'Event Timer' parameter serves for setting a cycle time (in milliseconds) for time-triggered transfer of the Transmit PDO3. The actual cycle time is inaccurate and can deviate from the set value by several milliseconds.

Processing of PDOs:

Transmit PDOs are transferred in the NMT status 'OPERATIONAL' only.

Changing PDO parameters:

PDO parameters can be changed in the NMT status 'PRE-OPERATIONAL' only.

9.13.2.26 1803_h: 4th Transmit PDO Parameter

The communication parameters of the fourth Transmit PDO (TPDO4) are set via object 1803_h.

Sub-index	00 _h
Description	largest sub-index supported
Access	read-only
PDO mapping	no
Data type	Unsigned8
Default	5
EEPROM	no

Sub-index	01 _h
Description	COB-ID
Access	read-write (recordable in the "Pre-Operational" state)
PDO mapping	no
Data type	Unsigned32
Default	480 _h + Node-ID
EEPROM	no

Sub-index	02 _h
Description	Transfer type (see chapter 9.3.5.4: Transfer types of the Transmit PDOs)
Access	read-write (recordable in the "Pre-Operational" state)
PDO mapping	no
Data type	Unsigned8
Default	253
EEPROM	no

Sub-index	03 _h
Description	Inhibit Time
Access	read-write (recordable in the "Pre-Operational" state)
PDO mapping	no
Unit	x 100 μ s
Data type	Unsigned16
Default	100
EEPROM	no

Sub-index	05 _h
Description	Event Timer
Access	read-write (recordable in the "Pre-Operational" state)
PDO mapping	no
Unit	milliseconds
Data type	Unsigned16
Default	0
EEPROM	no
Value range	0 ... 65535 The service is switched off by writing the value 0.

Format description sub-index 01_h:

Bit 31	0 = PDO exists / is valid 1 = PDO does not exist / is not valid
Bit 30	0 = request via RTR frame enabled 1 = request via RTR frame disabled
Bit 29	0 = 11-bit identifier (CAN 2.0A) 1 = 29-bit identifier (CAN 2.0B)
Bit 28 - 11	if bit 29=1, bit 28 ... 11 of the 29-bit identifier
Bit 10 - 7	4 bit function code of the identifier
Bit 6 - 0	7 bit Node-ID of the identifier

Data description sub-index 02_h:

0	synchronous: acyclic, PDO is sent after each SYNC message.
1 ... 240	synchronous: cyclic, PDO is sent after 1 ... 240 SYNC messages received.
241 ... 251	reserved
252	reserved
253	asynchronous: only on request (RTR frame). PDO is sent immediately after receipt of the RTR frame. Notice! Must have been enabled via bit 30 of sub-index 1.
254	asynchronous: Event-triggered (with every change of a mapped object and time-controlled).
255	asynchronous: time-triggered

PDO mapping:

See object 1A03_h (4th transmit PDO mapping parameter).

Inhibit Time:

A send-inhibit time is specified by the 'Inhibit Time' parameter (only for transmit type 254). Resolution is a multiple of 100 µs. The actual send-inhibit time is inaccurate and can deviate from the set value by several milliseconds.

Event Timer:

The 'Event Timer' parameter serves for setting a cycle time (in milliseconds) for time-triggered transfer of the Transmit PDO4. The actual cycle time is inaccurate and can deviate from the set value by several milliseconds.

Processing of PDOs:

Transmit PDOs are transferred in the NMT status 'OPERATIONAL' only.

Changing PDO parameters:

PDO parameters can be changed in the NMT status 'PRE-OPERATIONAL' only.

9.13.2.27 1A00_h: 1st Transmit PDO Mapping Parameter

Object 1A00_h determines the objects that are mapped on the first Transmit PDO (TPDO1).

Sub-index	00 _h
Description	Number of mapped application objects in TPDO 1
Access	read-only
PDO mapping	no
Data type	Unsigned8
Default	1
EEPROM	no

Sub-index	01 _h
Description	first object mapped
Access	read-only
PDO mapping	no
Data type	Unsigned32
Default	60410010 _h
EEPROM	no

Format description sub-index 01_h:

Bit 31 - 16	index 16 bits
Bit 15 - 8	sub-index 8 bits
Bit 7 - 0	8 bits object length

Data description:

The object cannot be changed (static mapping).

Mapped objects:

- Object 6041_h (status word) in bytes 0 and 1.

9.13.2.28 1A01_h: 2nd Transmit PDO Mapping Parameter

Object 1A01_h was implemented for compatibility reasons only and has no function.

Sub-index	00 _h
Description	Number of mapped application objects in TPDO 2
Access	read-only
PDO mapping	no
Data type	Unsigned8
Default	0
EEPROM	no

9.13.2.29 1A02_h: 3rd Transmit PDO Mapping Parameter

Object 1A02_h determines the objects that are mapped on the third Transmit PDO (TPDO3).

Sub-index	00 _h
Description	Number of mapped application objects in TPDO 3
Access	read-only
PDO mapping	no
Data type	Unsigned8
Default	2
EEPROM	no

Sub-index	01 _h
Description	first object mapped
Access	read-only
PDO mapping	no
Data type	Unsigned32
Default	60410010 _h
EEPROM	no

Sub-index	02 _h
Description	second object mapped
Access	read-only
PDO mapping	no
Data type	Unsigned32
Default	60640020 _h
EEPROM	no

Format description sub-index 01_h – 02_h:

Bit 31 - 16	index 16 bits
Bit 15 - 8	sub-index 8 bits
Bit 7 - 0	8 bits object length

Data description:

The object cannot be changed (static mapping).

Mapped objects:

- Object 6041_h (status word) in bytes 0 and 1.
- Object 6064_h (position actual value) in bytes 2 to 5.

9.13.2.30 1A03_h: 4th Transmit PDO Mapping Parameter

Object 1A03_h determines the objects that are mapped on the fourth Transmit PDO (TPDO4).

Sub-index	00 _h
Description	Number of mapped application objects in TPDO 4
Access	read-only
PDO mapping	no
Data type	Unsigned8
Default	2
EEPROM	no

Sub-index	01 _h
Description	first object mapped
Access	read-only
PDO mapping	no
Data type	Unsigned32
Default	60410010 _h
EEPROM	no

Sub-index	02 _h
Description	second object mapped
Access	read-only
PDO mapping	no
Data type	Unsigned32
Default	606C0020 _h
EEPROM	no

Format description sub-index 01_h – 02_h:

Bit 31 - 16	index 16 bits
Bit 15 - 8	sub-index 8 bits
Bit 7 - 0	8 bits object length

Data description:

The object cannot be changed (static mapping).

Mapped objects:

- Object 6041_h (status word) in bytes 0 and 1.
- Object 606C_h (velocity actual value) in bytes 2 to 5.

9.13.2.31 2001_h: Manufacturer Offset

Sub-index	00 _h
Description	Manufacturer-specific offset value (see chapter 8: Parameter description ⇒ Parameter no. 32)
Access	read-write (recordable in the "Pre-Operational" and "Operational" states, cannot be written with active travel job)
PDO mapping	no
Data type	Integer32
Default	0
EEPROM	yes
Value range	-999999 ... 999999

9.13.2.32 2100_h: CAN baud rate

The CAN baud rate is set via object 2100_h.

Sub-index	00 _h
Description	CAN baud rate (see chapter 8: Parameter description ⇒ Parameter no. 33)
Access	read-write (recordable in the "Pre-Operational" and "Operational" states) The baud rate set here will only be applied after re-initialisation of communication or power-up.
PDO mapping	no
Data type	Unsigned8
Default	3
EEPROM	yes
Value range	1 ... 7

Data description:

Value = 1:	1 Mbit/s
Value = 2:	800 kbit/s
Value = 3:	500 kbit/s
Value = 4:	250 kbit/s
Value = 5:	125 kbit/s
Value = 6:	50 kbit/s
Value = 7:	20 kbit/s

9.13.2.33 2101_n: Node-ID

The set node ID of the actuator can be read via object 2101_n.

Sub-index	00 _n
Description	Node-ID (see chapter 8: Parameter description ⇒ Parameter no. 22)
Access	read-write (recordable in the "Pre-Operational" and "Operational" states) The node ID set here will only be applied after re-initialisation of communication or power-up Node-ID.
PDO mapping	no
Data type	Unsigned8
Default	1
EEPROM	yes
Value range	1 ... 127

9.13.2.34 2102_n: Gear reduction

The gear reduction of the actuator can be read out via object 2102_n.

Sub-index	00 _n
Description	Gear reduction (see chapter 8: Parameter description ⇒ Parameter no. 72)
Access	read
PDO mapping	no
Data type	Unsigned8
Default	no
EEPROM	no
Value range	2, 3

Data description:

Value = 2: Gear reduction 188:1

Value = 3: Gear reduction 368:1

9.13.2.35 2400_n: Display and Operation Parameter Set

The object 2400_n contains all adjustable parameters regarding display and operation.

Sub-index	00 _n
Description	largest sub-index supported
Access	read-only
PDO mapping	no
Data type	Unsigned8
Default	13
EEPROM	no

Sub-index	01 _h
Description	Number of decimal places (see chapter 8: Parameter description ⇒ Parameter no. 42)
Access	read-write (recordable in the "Pre-Operational" and "Operational" states)
PDO mapping	no
Data type	Unsigned8
Default	0
EEPROM	yes
Value range	0 ... 4

Sub-index	02 _h
Description	Display divisor (see chapter 8: Parameter description ⇒ Parameter Nr. no 43)
Access	read-write (recordable in the "Pre-Operational" and "Operational" states)
PDO mapping	no
Data type	Unsigned8
Default	0
EEPROM	yes
Value range	0 ... 3

Sub-index	03 _h
Description	Direction indication function (see chapter 8: Parameter description ⇒ Parameter no. 44)
Access	read-write (recordable in the "Pre-Operational" and "Operational" states)
PDO mapping	no
Data type	Unsigned8
Default	0
EEPROM	yes
Value range	0 ... 2

Sub-index	04 _h
Description	Display orientation (see chapter 8: Parameter description ⇒ Parameter no. 45)
Access	read-write (recordable in the "Pre-Operational" and "Operational" states)
PDO mapping	no
Data type	Unsigned8
Default	0
EEPROM	yes
Value range	0 ... 1

Sub-index	05 _h
Description	PIN change (see chapter 8: Parameter description ⇒ Parameter no. 48)
Access	read-write (recordable in the "Pre-Operational" and "Operational" states)
PDO mapping	no
Data type	Unsigned8
Default	0
EEPROM	yes
Value range	0 ... 99999

Sub-index	06 _h
Description	Displayed value 2 nd display line (see chapter 8: Parameter description ⇒ Parameter no. 49)
Access	read-write (recordable in the "Pre-Operational" and "Operational" states)
PDO mapping	no
Data type	Unsigned8
Default	0
EEPROM	yes
Value range	0 ... 7

Sub-index	07 _h
Description	Key enable time (see chapter 8: Parameter description ⇒ Parameter no. 37)
Access	read-write (recordable in the "Pre-Operational" and "Operational" states)
PDO mapping	no
Data type	Unsigned8
Default	3
EEPROM	yes
Value range	1 ... 60

Sub-index	08 _h
Description	Key function enable (see chapter 8: Parameter description ⇒ Parameter no. 38)
Access	read-write (recordable in the "Pre-Operational" and "Operational" states)
PDO mapping	no
Data type	Unsigned8
Default	0
EEPROM	yes
Value range	0 ... 1

Sub-index	09 _h
Description	Key enable
Access	read-write (recordable in the "Pre-Operational" state)
PDO mapping	no
Data type	Unsigned8
Default	0
EEPROM	no
Value range	0 ... 1

Sub-index	0A _h
Description	LED 2 orange (see chapter 8: Parameter description ⇒ Parameter no. 39)
Access	read-write (recordable in the "Pre-Operational" and "Operational" states)
PDO mapping	no
Data type	Unsigned8
Default	1
EEPROM	yes
Value range	0 ... 1

Sub-index	0B _h
Description	LED 1 red (see chapter 8: Parameter description ⇒ Parameter no. 40)
Access	read-write (recordable in the "Pre-Operational" and "Operational" states)
PDO mapping	no
Data type	Unsigned8
Default	1
EEPROM	yes
Value range	0 ... 1

Sub-index	0C _h
Description	LED 1 green (see chapter 8: Parameter description ⇒ Parameter no. 41)
Access	read-write (recordable in the "Pre-Operational" and "Operational" states)
PDO mapping	no
Data type	Unsigned8
Default	1
EEPROM	yes
Value range	0 ... 1

Sub-index	0D _n
Description	Display divisor application (see chapter 8: Parameter description ⇒ Parameter no. 74)
Access	read-write (recordable in the "Pre-Operational" and "Operational" states)
PDO mapping	no
Data type	Unsigned8
Default	0
EEPROM	yes
Value range	0 ... 1

9.13.2.36 2410_n: Motor Parameter Set

Object 2410_n contains all adjustable control parameters of the drive controller.

Sub-index	00 _n
Description	largest sub-index supported
Access	read-only
PDO mapping	no
Data type	Unsigned8
Default	9
EEPROM	no

Sub-index	01 _n
Description	Controller parameter P (see chapter 8: Parameter description ⇒ Parameter no. 1)
Access	read-write (recordable in the "Pre-Operational" and "Operational" states, cannot be written with active travel job)
PDO mapping	no
Data type	Unsigned16
Default	300
EEPROM	yes
Value range	1 ... 500

Sub-index	02 _n
Description	Controller parameter I (see chapter 8: Parameter description ⇒ Parameter no. 2)
Access	read-write (recordable in the "Pre-Operational" and "Operational" states, cannot be written with active travel job)
PDO mapping	no
Data type	Unsigned16
Default	2
EEPROM	yes
Value range	0 ... 500

Sub-index	03 _h
Description	Controller parameter D (see chapter 8: Parameter description ⇒ Parameter no. 3)
Access	read-write (recordable in the "Pre-Operational" and "Operational" states, cannot be written with active travel job)
PDO mapping	no
Data type	Unsigned16
Default	0
EEPROM	yes
Value range	0 ... 500

Sub-index	04 _h
Description	a - Pos (acceleration positioning mode) (see chapter 8: Parameter description ⇒ Parameter no. 4)
Access	read-write (recordable in the "Pre-Operational" and "Operational" states, cannot be written with active travel job)
PDO mapping	no
Data type	Unsigned8
Default	50
EEPROM	yes
Value range	1 ... 100

Sub-index	05 _h
Description	v - Pos (velocity positioning mode) (see chapter 8: Parameter description ⇒ Parameter no. 5)
Access	read-write (recordable in the "Pre-Operational" and "Operational" states, cannot be written with active travel job)
PDO mapping	no
Data type	Unsigned8
Default	10
EEPROM	yes
Value range	Gear 188:1 ⇒ 1 – 30 rpm Gear 368:1 ⇒ 1 – 15 rpm

Sub-index	06 _h
Description	a – Rot (acceleration velocity mode) (see chapter 8: Parameter description ⇒ Parameter no. 6)
Access	read-write (recordable in the "Pre-Operational" and "Operational" states, cannot be written with active travel job)
PDO mapping	no
Data type	Unsigned8
Default	50
EEPROM	yes
Value range	1 ... 100

Sub-index	08 _h
Description	a – Inch (acceleration inching operation) (see chapter 8: Parameter description ⇒ Parameter no. 8)
Access	read-write (recordable in the "Pre-Operational" and "Operational" states, cannot be written with active travel job)
PDO mapping	no
Data type	Unsigned8
Default	50
EEPROM	yes
Value range	1 ... 100

Sub-index	09 _h
Description	v – Inch (velocity inching operation (see chapter 8: Parameter description ⇒ Parameter no. 9))
Access	read-write (recordable in the "Pre-Operational" and "Operational" states, cannot be written with active travel job)
PDO mapping	no
Data type	Unsigned8
Default	10
EEPROM	yes
Value range	Gear 188:1 ⇒ 1 – 30 rpm Gear 368:1 ⇒ 1 – 15 rpm

9.13.2.37 2412_h: Spindle Pitch

Spindle pitch is set via object 2412_h.

Sub-index	00 _h
Description	Spindle pitch (see chapter 8: Parameter description ⇒ Parameter no. 13)
Access	read-write (recordable in the "Pre-Operational" and "Operational" states, cannot be written with active travel job)
PDO mapping	no
Data type	Unsigned32
Default	0
EEPROM	yes
Value range	1 ... 1000000

9.13.2.38 2413_h: Pos Type

The positioning type is set via object 2413_h.

Sub-index	00 _h
Description	Positioning type (see chapter 8: Parameter description ⇒ Parameter no. 19)
Access	read-write (recordable in the "Pre-Operational" and "Operational" states, cannot be written with active travel job)
PDO mapping	no
Data type	Unsigned32
Default	0
EEPROM	yes
Value range	0 ... 2

Data description:

Value = 0: direct
 Value = 1: loop +
 Value = 2: loop -

9.13.2.39 2415_h: Delta Jog

The travel distance in inching operation 1 is set via object 2415_h.

Sub-index	00 _h
Description	Travel distance inching operation 1 (see chapter 8: Parameter description ⇒ Parameter no. 17)
Access	read-write (recordable in the "Pre-Operational" and "Operational" states, cannot be written with active travel job)
PDO mapping	no
Data type	Integer32
Default	720
EEPROM	yes
Value range	-1000000 ... +1000000

9.13.2.40 2416_h: Stop Mode Inching Mode 2

The stop behaviour in inching mode 2 is set via object 2416_h.

Sub-index	00 _h
Description	stop mode inching 2 (see chapter 8: Parameter description ⇒ Parameter no. 25)
Access	read-write (recordable in the "Pre-Operational" and "Operational" states, cannot be written with active travel job)
PDO mapping	no
Data type	Unsigned32
Default	0
EEPROM	yes
Value range	0 ... 1

9.13.2.41 2417_h: Inpos Mode

The drive's behaviour when reaching the positioning window is defined by object 2417_h.

Sub-index	00 _h
Description	Inpos Mode (see chapter 8: Parameter description ⇒ Parameter no. 26)
Access	read-write (recordable in the "Pre-Operational" and "Operational" states, cannot be written with active travel job)
PDO mapping	no
Data type	Unsigned8
Default	0
EEPROM	yes
Value range	0 ... 2

9.13.2.42 2418_h: Loop Length

Loop length is determined by object 2418_h.

Sub-index	00 _h
Description	Loop Length (see chapter 8: Parameter description ⇒ Parameter no. 27)
Access	read-write (recordable in the "Pre-Operational" and "Operational" states, cannot be written with active travel job)
PDO mapping	no
Data type	Unsigned16
Default	360
EEPROM	yes
Value range	0 ... 30000

9.13.2.43 2419_h: Contouring Error Limit

The contouring error limit can be set via object 2419_h.

Sub-index	00 _h
Description	Contouring error limit (see chapter 8: Parameter description ⇒ Parameter no. 28)
Access	read-write (recordable in the "Pre-Operational" and "Operational" states, cannot be written with active travel job)
PDO mapping	no
Data type	Unsigned16
Default	400
EEPROM	yes
Value range	1 ... 30000

9.13.2.44 241A_h: Contouring Error

The current contouring error can be read via object 241A_h.

Sub-index	00 _h
Description	Current contouring error
Access	read-only
PDO mapping	no
Data type	Integer16
Default	no
EEPROM	no

9.13.2.45 241B_n: Power Supply Voltage

Object 241B_n contains the supply voltages.

Sub-index	00 _n
Description	largest sub-index supported
Access	read-only
PDO mapping	no
Data type	Unsigned8
Default	2
EEPROM	no

Sub-index	01 _n
Description	Output stage supply voltage (see chapter 8: Parameter description ⇒ Parameter no. 52)
Access	read-only
PDO mapping	no
Data type	Unsigned16
Default	no
EEPROM	no

Sub-index	02 _n
Description	Control supply voltage (see chapter 8: Parameter description ⇒ Parameter no. 51)
Access	read-only
PDO mapping	no
Data type	Unsigned16
Default	no
EEPROM	no

9.13.2.46 241C_n: Output Stage Temperature

Object 241C_n contains the output stage temperature.

Sub-index	00 _n
Description	Output stage temperature (see chapter 8: Parameter description ⇒ Parameter no. 50)
Access	read-only
PDO mapping	no
Data type	Integer16
Default	no
EEPROM	no

9.13.2.47 241E_n: Motor Current

Object 241E_n contains the actual motor current.

Sub-index	00 _n
Description	Motor current (see chapter 8: Parameter description ⇒ Parameter no. 54)
Access	read-only
PDO mapping	no
Data type	Integer16
Default	no
EEPROM	no

9.13.2.48 2421_n: Motor Current Limit

Motor current limitation is set via object 2421_n.

Sub-index	00 _n
Description	Motor current limitation (see chapter 8: Parameter description ⇒ Parameter no. 29)
Access	read-write (recordable in the "Pre-Operational" and "Operational" states, cannot be written with active travel job)
PDO mapping	no
Data type	Unsigned8
Default	110
EEPROM	yes
Value range	25 ... 110

9.13.2.49 2423_n: Battery Voltage

Object 2423_n contains the current battery voltage.

Sub-index	00 _n
Description	Battery voltage (see chapter 8: Parameter description ⇒ Parameter no. 53)
Access	read-only
PDO mapping	no
Data type	Integer16
Default	no
EEPROM	no

9.13.2.50 2450_n: Inching 2 Offset

An offset value can be set in inching operation 2 via object 2450_n.

Sub-index	00 _n
Description	Offset value in inching operation 2 (see chapter 8: Parameter description ⇒ Parameter no. 30)
Access	read-write (recordable in the "Pre-Operational" and "Operational" states)
PDO mapping	no
Data type	Unsigned8
Default	100
EEPROM	no
Value range	10 ... 100

9.13.2.51 2451_n: Type of acceleration Inching mode 2

The type of acceleration can be set in inching operation 2 via object 2451_n.

Sub-index	00 _n
Description	Type of acceleration in inching operation 2 (see chapter 8: Parameter description ⇒ Parameter no. 31)
Access	read-write (recordable in the "Pre-Operational" and "Operational" states, cannot be written with active travel job)
PDO mapping	no
Data type	Unsigned8
Default	0
EEPROM	yes
Value range	0 ... 1

9.13.2.52 2500_n: Production Date

Object 2500_n indicates the production date.

Sub-index	00 _n
Description	date of production in readable hex notation (see chapter 8: Parameter description ⇒ Parameter no. 58)
Access	read-only
PDO mapping	no
Data type	Unsigned32
Default	no
EEPROM	yes

Format description (example):

15 07 20 09_n = 15.07.2009 = DDMMJJJJ

9.13.2.53 2501_h: Display Software Version

Object 2501_h indicates the software version of the display controller firmware.

Sub-index	00 _h
Description	Software version in ASCII characters
Access	const
PDO mapping	no
Data type	Visible String
Default	no
EEPROM	no

Format description (example):

Bit 7 - 0	31 _h = ' 1 ' (ASCII character, ISO 8859)
Bit 15 - 8	2E _h = ' . ' (ASCII character, ISO 8859)
Bit 23 - 16	30 _h = ' 0 ' (ASCII character, ISO 8859)
Bit 31 - 24	30 _h = ' 0 ' (ASCII character, ISO 8859)

Software version = V 1.00

9.13.2.54 6040_h: Control word

The object 6040_h is the control word of the state machine for drives according to the device profile CiA DSP-402.

Sub-index	00 _h
Description	control word
Access	read-write (recordable in the "Pre-Operational" and "Operational" states)
PDO mapping	yes
Data type	Unsigned16
Default	no
EEPROM	no

Format description:

See chapter 9.6: [Control word](#)

PDO mapping:

The control word is mapped on the three Receive PDOs (see objects 1600_h – 1603_h).

9.13.2.55 6041_h: Status word

The object 6041_h is the status word of the state machine for drives according to the device profile CiA DSP-402.

Sub-index	00 _h
Description	Status word
Access	read-only
PDO mapping	yes
Data type	Unsigned16
Default	no
EEPROM	no

Format description:

See chapter 9.5: [Status word](#)

PDO mapping:

The status word is mapped on the three Transmit PDOs (see objects 1A00_h – 1A03_h).

9.13.2.56 6060_h: Modes of Operation

The operation mode of the actuator is set via object 6060_h.

Sub-index	00 _h
Description	Operating mode (see chapter 8: Parameter description ⇒ Parameter no. 20)
Access	read-write (recordable in the "Pre-Operational" and "Operational" states, cannot be written with active travel job)
PDO mapping	no
Data type	Integer8
Default	1
EEPROM	yes
Value range	1 ... 2

Data description:

Value = 1: Profile Position Mode (positioning mode)

Value = 2: Profile Velocity Mode (velocity mode)

9.13.2.57 6061_n: Modes of Operation Display

The operating mode set can be read via object 6061_n.

Sub-index	00 _n
Description	Operating mode (see chapter 8: Parameter description ⇒ Parameter no. 20)
Access	read-only
PDO mapping	no
Data type	Integer8
Default	no
EEPROM	no

Data description:

Value = 1: Profile Position Mode (positioning mode)
 Value = 2: Profile Velocity Mode (velocity mode)

9.13.2.58 6064_n: Position Actual Value

Object 6064_n contains the actual position value in the Profile Position Mode (positioning mode).

Sub-index	00 _n
Description	absolute position value in the positioning mode
Access	read-only
PDO mapping	yes
Data type	Integer32
Default	no
EEPROM	no

PDO mapping:

The absolute position value and the status word of the state machine are mapped on the Transmit PDO3, see object 1A02_n (3rd Transmit PDO mapping parameter).

9.13.2.59 6067_h: Position Window

A symmetric range of tolerable positions for standstill monitoring in the target point of positioning is set via object 6067_h.

Sub-index	00 _h
Description	Pos- window (see chapter 8: Parameter description ⇒ Parameter no. 10)
Access	read-write (recordable in the "Pre-Operational" and "Operational" states, cannot be written with active travel job)
PDO mapping	no
Data type	Unsigned32
Default	10
EEPROM	yes
Value range	0 ... 1000

9.13.2.60 606C_h: Velocity Actual Value

Object 606C_h contains the actual velocity in the Profile Velocity Mode (velocity mode).

Sub-index	00 _h
Description	Actual velocity in velocity mode
Access	read-only
PDO mapping	yes
Data type	Integer32
Default	no
EEPROM	no

PDO mapping:

The actual velocity and the status word of the state machine are mapped on the Transmit PDO4, see object 1A03_h (4th Transmit PDO mapping parameter).

9.13.2.61 607A_h: Target Position

The target position of a drive movement in the operation mode Profile Position Mode (position mode) is entered via object 607A_h.

Sub-index	00 _h
Description	setpoint in the positioning mode
Access	read-write (recordable in the "Pre-Operational" and "Operational" states, cannot be written with active travel job)
PDO mapping	yes
Data type	Integer32
Default	no
EEPROM	no
Value range	±9999999

PDO mapping:

The target position and the control word of the state machine are mapped on the Receive PDO3, see object 1602_h (3rd Receive PDO mapping parameter).

9.13.2.62 607C_h: Calibration Value

The calibration value is programmed and the programmed calibration value taken over as the absolute position value via object 607C_h.

Sub-index	00 _h
Description	Calibration value (see chapter 8: Parameter description ⇒ Parameter no. 14 and chapter 5: Calibration)
Access	read-write (recordable in the "Pre-Operational" and "Operational" states, cannot be written with active travel job)
PDO mapping	no
Data type	Integer32
Default	0
EEPROM	yes
Value range	±999999

9.13.2.63 607D_h: Software Position Limit

Via object 607D_h, the software limit switches defining the working range of the drive are set.

Sub-index	00 _h
Description	Number of subindexes
Access	read-only
PDO mapping	no
Data type	Unsigned8
Default	2
EEPROM	no

Sub-index	01 _h
Description	Limit 2 (see chapter 8: Parameter description ⇒ Parameter no. 16)
Access	read-write (recordable in the "Pre-Operational" and "Operational" states, cannot be written with active travel job)
PDO mapping	no
Data type	Integer32
Default	-19999
EEPROM	yes
Value range	±9999999

Sub-index	02 _n
Description	Limit 1 (see chapter 8: Parameter description ⇒ Parameter no. 15)
Access	read-write (recordable in the "Pre-Operational" and "Operational" states, cannot be written with active travel job)
PDO mapping	no
Data type	Integer32
Default	99999
EEPROM	yes
Value range	±9999999

9.13.2.64 607E_n: Polarity

The polarity of the drive's sense of rotation is set via object 607E_n.

Sub-index	00 _n
Description	Sense of rotation (see chapter 8: Parameter description ⇒ Parameter no. 18)
Access	read-write (recordable in the "Pre-Operational" and "Operational" states, cannot be written with active travel job)
PDO mapping	no
Data type	Unsigned8
Default	0
EEPROM	yes
Value range	0 ... 1

Data description:

Value '0' = sense of rotation 'i'.
 Value '1' = sense of rotation 'e'.

9.13.2.65 6091_n: Gear Ratio

A gear ratio can be programmed via object 6091_n.

Sub-index	00 _n
Description	Number of subindexes
Access	read-only
PDO mapping	no
Data type	Unsigned8
Default	2
EEPROM	no

Sub-index	01 _h
Description	Numerator gear ratio (see chapter 8: Parameter description ⇒ Parameter no. 11)
Access	read-write (recordable in the "Pre-Operational" and "Operational" states, cannot be written with active travel job)
PDO mapping	no
Data type	Unsigned32
Default	1
EEPROM	yes
Value range	1 ... 10000

Sub-index	02 _h
Description	Denominator gear ratio (see chapter 8: Parameter description ⇒ Parameter no. 12)
Access	read-write (recordable in the "Pre-Operational" and "Operational" states, cannot be written with active travel job)
PDO mapping	no
Data type	Unsigned32
Default	1
EEPROM	yes
Value range	1 ... 10000

See also chapter 6: [External gear](#).

9.13.2.66 60FF_h: Target Velocity

The target velocity of a drive movement in the operation mode Profile Velocity Mode (velocity mode) is entered via object 60FF_h.

Sub-index	00 _h
Description	Target velocity in the velocity mode of operation
Access	read-write (recordable in the "Pre-Operational" and "Operational" states)
PDO mapping	yes
Data type	Integer32
Default	no
EEPROM	no
Value range	Gear 188:1 ⇒ ±30 rpm Gear 368:1 ⇒ ±15 rpm

PDO mapping:

The target velocity and the control word of the state machine are mapped on the Receive PDO4, see object 1603_h (4th Receive PDO mapping parameter).