



2020

Data **sheet** *Datenblatt*



Specifications are subject to changes without notice. The diagrams are based on 24 VDC. It is the user's responsibility to verify the compatibility of SIR/ Schumo products for the foreseen application. No responsibility will be taken from the manufacturer's side.

Technische Änderungen vorbehalten. Die Diagramme basieren auf einer Betriebsspannung von 24 VDC. Es liegt in der Verantwortung des Anwenders sich zu vergewissern, dass das SIR / Schumo Produkt des Einsatzgebietes entsprechend verwendet wird. Diesbezüglich übernimmt der Hersteller keine Garantie.

Index

Linear actuators *Linearantriebe*

S-LINE	4
AO-t01	
AO-01/M	
AO-01/V	
M-LINE	8
AO-1	
AO-1/M	
AO-1/V	
AO-1/M AC	
L-LINE	13
AO-4	
AO-4/M	
AO-4/V	
XL-LINE	17
AO-6/M	
AO-36/M	
AO-3 AC	
AO-36/M AC	
SIGARO-LINE	22
AL-01	
AL-01/M	
AL-3	
AL-3/M	
COMPACT-LINE	27
AOP-1/M	
AOP-1/Mi	
AOP-1/M agri	
AOP-1/Mt	
AOP-2/M	
AOP-2/Mi	
AOP-2/M agri	
FLEXI-LINE	35
AP-3	
AP-3/C	
AP-3/V	
AP-3 AC	
AP-3/C AC	
RAMB-01 - LINE	41
Ramb-01/M	
Ramb-01/SP	
Ramb-01/TH	
APF-01	
<i>Gearmotors Getriebemotoren</i>	
RAO-LINE	46
RAO-02	
RAO-4	
SLIM2.1	
<i>Telescopic column Teleskop - Hubsäule</i>	
TECH FOCUS ON	
TRI-X - SYNCRO - DUAL DRIVE	50
L SCOPIC	51
R SCOPIC	57
<i>Accessories - Zubehör</i>	
Electric boards	58
Handset & Footswitch	
<i>Handshalter & Fußschalter</i>	59

S LINE

Compact and robust actuator family.
Up to 800N & 51mm/s.

*Kompakte und robuste Antriebsfamilie.
Leistungen bis 800N - Geschwindigkeiten
bis 51mm/sek.*



AO-01
AO-01/M
AO-01/V

AO-01



Full metal body actuator
 Ideal for narrow spaces
 Right or Left-hand motor mounting position available
 Compact rod dimension

*Alle tragenden Teile aus Metall
 Ideal für engste Bauräume
 Motorposition links und rechts verfügbar
 Kompakte Befestigungsösen*

Features Technische Merkmale	
DC Motors DC Motoren	12÷24÷36 V
Aluminium rod Alu Kolbenstange	
Standard protection Schutzart	IP44
Duty cycle Einschaltdauer	S3 10% based on 10 min. S3 10% basierend auf 10 min.
Operating temperature Betriebstemperatur	-10C° ÷ +60C°
Options Optionen	
Encoder Permanente, digitale Lagerückmeldung	
Increased IP Erhöhte Schutzart	
Customizable stroke and retracted length Kundenspezifische Hübe und eingefahrene Längen	
Various rear and front attachments available (0° and 90°) Befestigungsösen in 0° und 90° Ausführung	

Max thrust Push/Pull [N] Max Kraft Druck / Zug	Max speed [mm/s] Max Geschw.	Stroke length [mm] Hublänge	Installation dim. [mm] Einbaulänge (D)
800	8	50÷300*	stroke/Hub + 90
500	16		
300	32		
200	51		
800	16E		
700	32E		
500	51E		

*Longer stroke available upon request | Längere Hübe auf Anfrage möglich

Speed vs. Load | Geschwindigkeit / Kraft

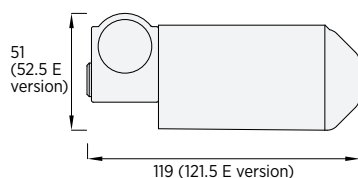
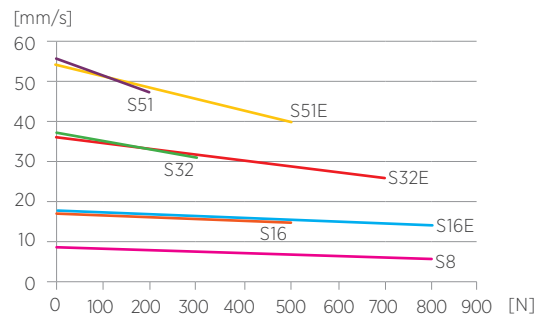

Current vs. Load | Stromaufnahme / Kraft

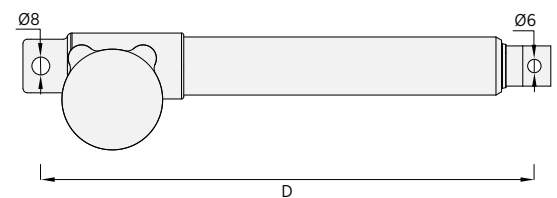
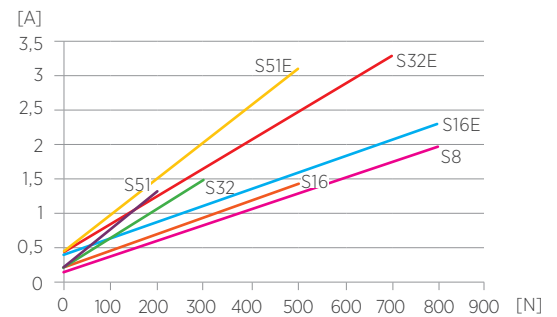

AO-01/M



- Full metal body actuator
- Compact overall building dimension
- Integrated and adjustable end-stroke limit switches
- Right or Left-hand motor mounting position available

*Alle tragenden Teile aus Metall
Sehr kompaktes Design
Integrierte Endschalter / Signalgeber
Endschalter / Signalgeber stufenlos einstellbar
Motorposition links und rechts verfügbar*



Features | Technische Merkmale

DC Motors DC Motoren	12÷24÷36 V
Aluminium rod Alu Kolbenstange	
Standard protection Schutzart	IP44
Duty cycle Einschaltdauer	S3 10% based on 10 min. S3 10% basierend auf 10 min.
Operating temperature Betriebstemperatur	-10C° ÷ +60C°

Options | Optionen

- Stainless steel rod | Kolbenstange in Edelstahl
- Encoder | Permanente, digitale Lagerückmeldung
- Anti rotation | Verdrehgesicherte Kolbenstange
- Increased IP | Erhöhte Schutzart
- Customizable stroke and retracted length | Kundenspezifische Hübe und eingefahrene Längen
- Various rear and front attachment available (0° and 90°) | Befestigungsaugen in 0° und 90° Ausführung

Max thrust Push/Pull [N] Max Kraft Druck / Zug	Max speed [mm/s] Max Geschw.	Stroke length [mm] Hublänge	Installation dim. [mm] Einbaulänge (D)
800	8	50÷300*	stroke/Hub + 94
500	16		stroke/Hub + 94
300	32		stroke/Hub + 97
200	51		stroke/Hub + 100
800	16 E		stroke/Hub + 94
700	32 E		stroke/Hub + 97
500	51 E		stroke/Hub + 100

*Longer stroke available upon request | Längere Hübe auf Anfrage möglich

Speed vs. Load | Geschwindigkeit / Kraft

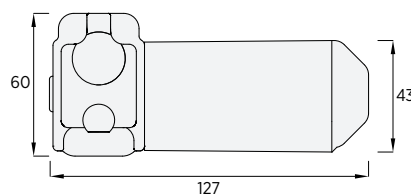
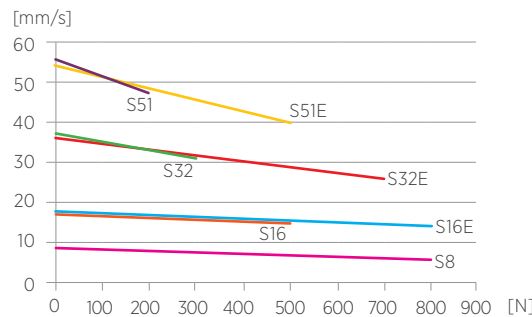

Current vs. Load | Stromaufnahme / Kraft

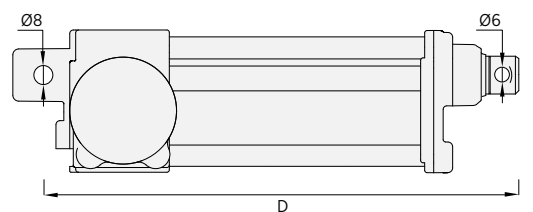
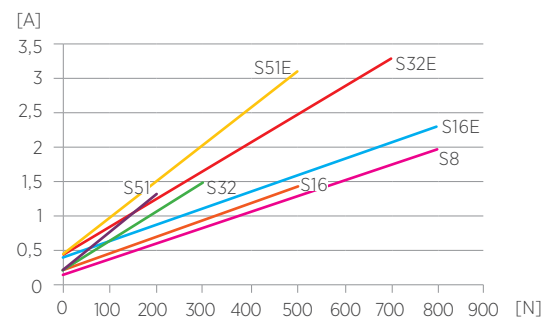

AO-01/V



- Minimum overall building dimension
- Customizable screw bar and gear ratio
- Customer based design nut
- Full metal body actuator
- Right or Left-hand motor mounting position available

Minimalste Abmessungen
Kundenspezifische Leistungsübersetzungen
Applikationspezifische Tragmutter
Metallkorpus
Motorposition links und rechts verfügbar



Features Technische Merkmale	
DC Motors DC Motoren	12÷24÷36 V
Built-in nut Tragmutter im Lieferumfang	
Duty cycle Einschaltdauer	S3 10% based on 10 min. S3 10% basierend auf 10 min.
Operating temperature Betriebstemperatur	-10C° ÷ +60C°
Options Optionen	
Encoder Permanente, digitale Lagerückmeldung	
Customizable nut and stroke Kundenspezifische Tragmutter - Ausführung	
Various rear attachments available (0° and 90°) Hintere Befestigung in 0° und 90° verfügbar	

Max thrust Push/Pull [N] Max Kraft Druck / Zug	Max speed [mm/s] Max Geschw.	Stroke length [mm] Hublänge	Installation dim. [mm] Einbaulänge (D)
800	8	50÷300*	stroke/Hub + 53
500	16		
300	32		
200	51		
800	16 E		
700	32 E		
500	51 E		

*Longer stroke available upon request | Längere Hübe auf Anfrage möglich

Speed vs. Load | Geschwindigkeit / Kraft

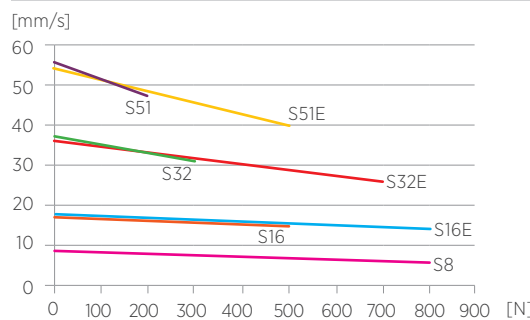

Current vs. Load | Stromaufnahme / Kraft

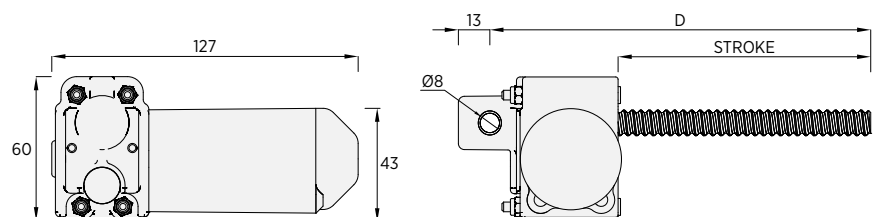
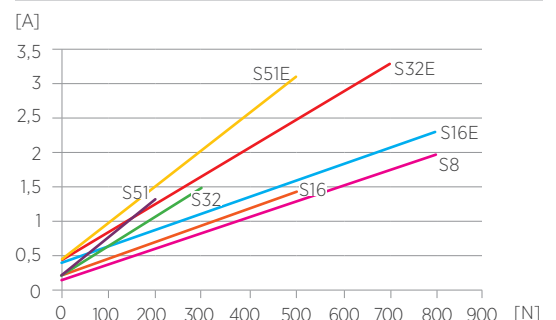

M LINE

Versatile and compact actuator family.
Up to 2.000N.

*Die vielseitige und kompakte
Antriebsfamilie.
Leistungen bis 2.000N.*

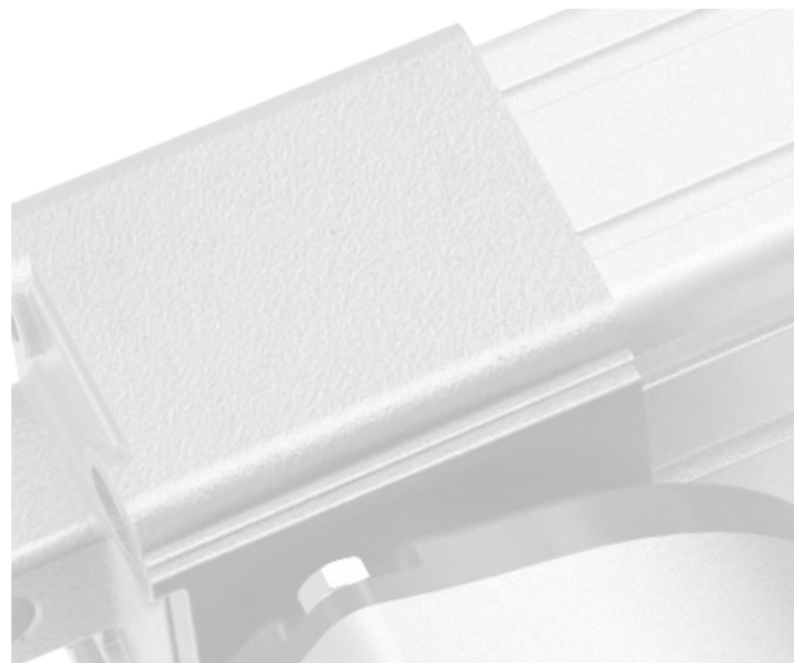

 **AO-1
AO-1/M**

  **AO-1/V**

 **AO-1/M**

AO-1



- Strong rear clevis attachment
- Full metal body actuator with stainless steel rod as standard
- Ideal for narrow spaces
- Right or Left-hand motor mounting position available
- Built-in encoder without affecting the standard overall dimensions

*Widerstandsfähige Gabelaufnahme
Metallkorpus mit Edelstahl Kolbenstange
Motorposition links und rechts verfügbar
Lagerückmeldungsgeber*



Features | Technische Merkmale

DC Motors DC Motoren	12÷24÷36 V
Standard protection Schutzart	IP44
Duty cycle Einschaltdauer	S3 10% based on 10 min. S3 10% basiert auf 10 min.
Operating temperature Betriebstemperatur	-10C° ÷ +60C°

Options | Optionen

Encoder Permanente, digitale Lagerückmeldung
Increased IP Erhöhte Schutzart
Customizable stroke and retracted length Kundenspezifische Hübe und eingefahrene Längen
Various rear and front attachments available (0° and 90°) Befestigungsaugen in 0° und 90° Ausführung

Max thrust Push/Pull [N] Max Kraft Druck / Zug	Max speed [mm/s] Max Geschw.	Stroke length [mm] Hublänge	Installation dim. [mm] Einbaulänge (D)
2000	10	50÷300*	stroke/Hub + 107
1500	20		
850	30		
800	53		

*Longer stroke available upon request | Längere Hübe auf Anfrage möglich

Speed vs. Load | Geschwindigkeit / Kraft

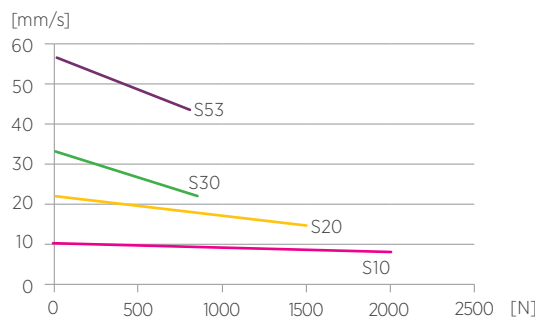

Current vs. Load | Stromaufnahme / Kraft

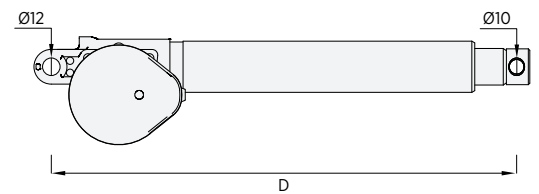
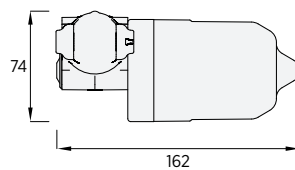
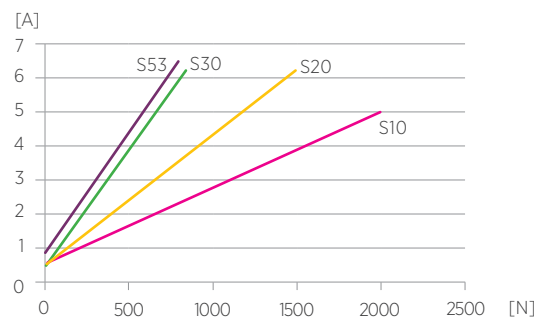

AO-1/M



Full metal body actuator with stainless steel rod as standard
 Integrated and adjustable end-stroke limit switches
 Right or Left-hand motor mounting position available
 Recommended for long strokes

*Metallkorpus mit Kolbenstange In Edelstahl
 Integrierte Endschalter / Signalgeber
 Endschalter / Signalgeber stufenlos einstellbar
 Motorposition links und rechts verfügbar
 Optimal für lange Hübe*

Features | Technische Merkmale

DC Motors DC Motoren	12÷24÷36 V
Standard protection Schutzart	IP44
Duty cycle Einschaltdauer	S3 10% based on 10 min. S3 10% basierend auf 10 min.
Operating temperature Betriebstemperatur	-10C° ÷ +60C°

Options | Optionen

Encoder Permanente, digitale Lagerückmeldung
Anti rotation Verdrehgesicherte Kolbenstange
Increased IP Erhöhte Schutzart
Customizable stroke and retracted length Kundenspezifische Hübe und eingefahrene Längen
Various rear and front attachments available (0° and 90°) Befestigungsaugen in 0° und 90° Ausführung

Max thrust Push/Pull [N] Max Kraft Druck / Zug	Max speed [mm/s] Max Geschw.	Stroke length [mm] Hublänge	Installation dim. [mm] Einbaulänge (D)
2000	10	50÷300*	stroke/Hub + 117
1500	20		
850	30		

*Longer stroke available upon request | Längere Hübe auf Anfrage möglich

Speed vs. Load | Geschwindigkeit / Kraft **Current vs. Load | Stromaufnahme / Kraft**

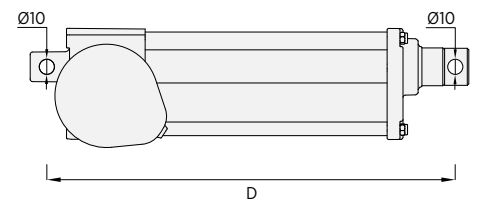
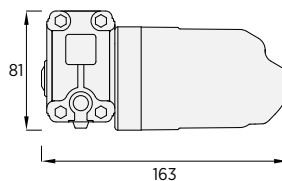
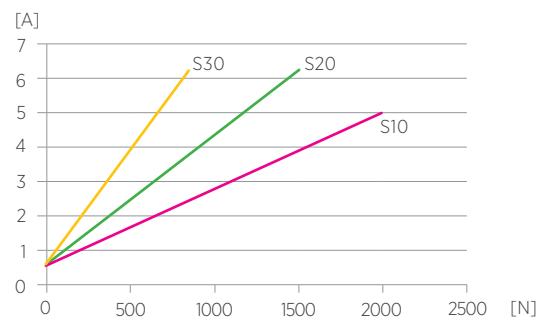
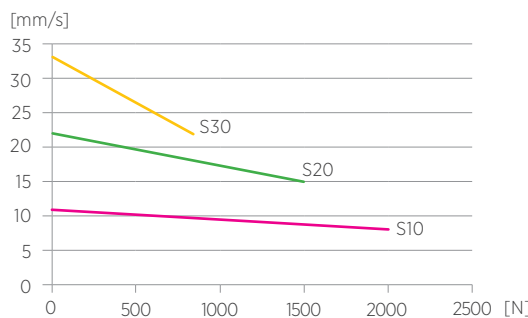

AO-1/V



- Minimum overall building dimension
- Customizable screw bar and gear ratio
- Customer based design nut
- Full metal body actuator
- Right or Left-hand motor mounting position available

*Minimalste Abmessungen
Kundenspezifische Leistungsübersetzungen
Applikationsspezifische Tragmutter
Metallkorpus
Motorposition links und rechts verfügbar*

Features | Technische Merkmale

AC Motors AC Motoren	Single-phase 230V 50Hz 230V, 50Hz, 1Ph.
DC Motors DC Motoren	12÷24÷36 V
Built-in nut Tragmutter im Lieferumfang	
Operating temperature Betriebstemperatur	-10C° ÷ +60C°

Options | Optionen

Encoder Permanente, digitale Lagerückmeldung
Customizable nut and stroke Kundenspezifische Tragmutter
Various rear attachments available (0° and 90°) Hintere Befestigung in 0° und 90° verfügbar

Max thrust Push/Pull [N] Max Kraft Druck / Zug	Max speed [mm/s] Max Geschw.	Stroke length [mm] Hublänge	Installation dim. [mm] Einbaulänge (D)
2000	10	50÷300*	stroke/Hub + 67
1500	20		
850	30		

*Longer stroke available upon request | Längere Hübe auf Anfrage möglich

Speed vs. Load | Geschwindigkeit / Kraft

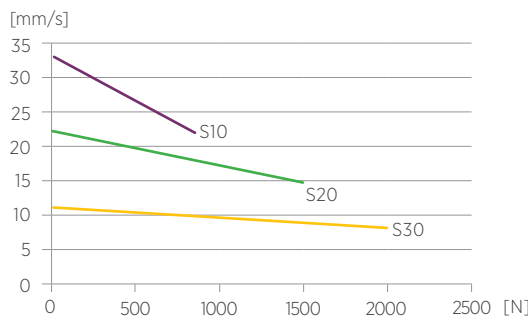

Current vs. Load | Stromaufnahme / Kraft

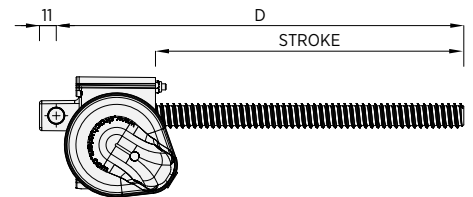
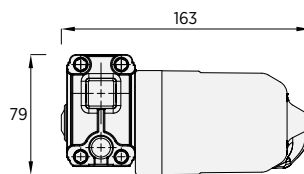
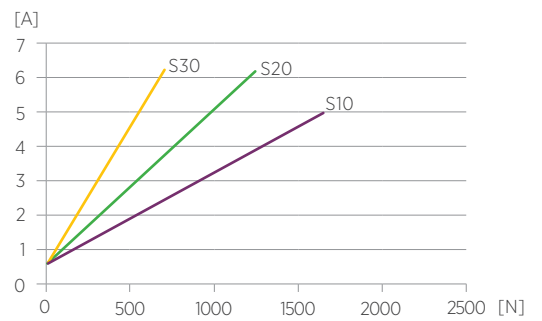

AO-1/M



- Standard industrial AC motor available
- Compact, own-design motor
- Full metal body actuator with stainless steel rod as standard
- Integrated and adjustable end-stroke limit switches
- Right or Left-hand motor mounting position available
- Recommended for long strokes

*Hochleistungs AC Wechselstrom Industriemotor
Metallkorpus mit Kolbenstange in Edelstahl
Integrierte Endschalter
Endschalter stufenlos einstellbar
Motorposition links und rechts verfügbar
Optimal für lange Hübe*

Features | Technische Merkmale

AC Motors Single-phase 230V 50Hz ÷ Three-phase 400V 50Hz AC Motoren 230V 50Hz. 1Ph. - 400V 50 Hz. 3Ph.
Standard protection Schutzart IP44
Operating temperature Betriebstemperatur -10C° ÷ +60C°

Options | Optionen

Encoder Permanente, digitale Lagerückmeldung
Anti rotation Verdrehgesicherte Kolbenstange
Increased IP Erhöhte Schutzart
Customizable stroke and retracted length Kundenspezifische Hübe und eingefahrene Längen
Various rear and front attachments available (0° and 90°) Befestigungsaugen in 0° und 90° Ausführung

Max thrust Push/Pull [N] Max Kraft Druck / Zug	Max speed [mm/s] Max Geschw.	Stroke length [mm] Hublänge	Installation dim. [mm] Einbaulänge (D)
2000	10	50÷300*	stroke/Hub +117
1500	20		
1500	30		

*Longer stroke available upon request | Längere Hübe auf Anfrage möglich

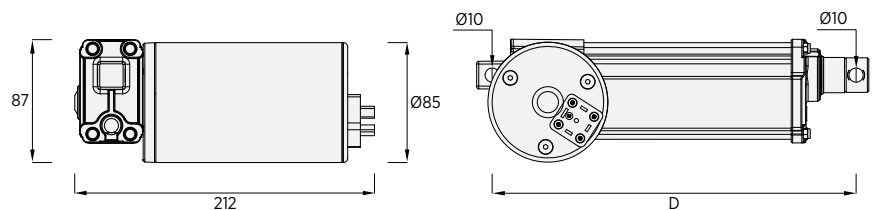

LINE

Compact and strong actuator family.
Up to 6.000N.

*Kompakte und starke Antriebsfamilie.
Leistungen bis 6.000N.*

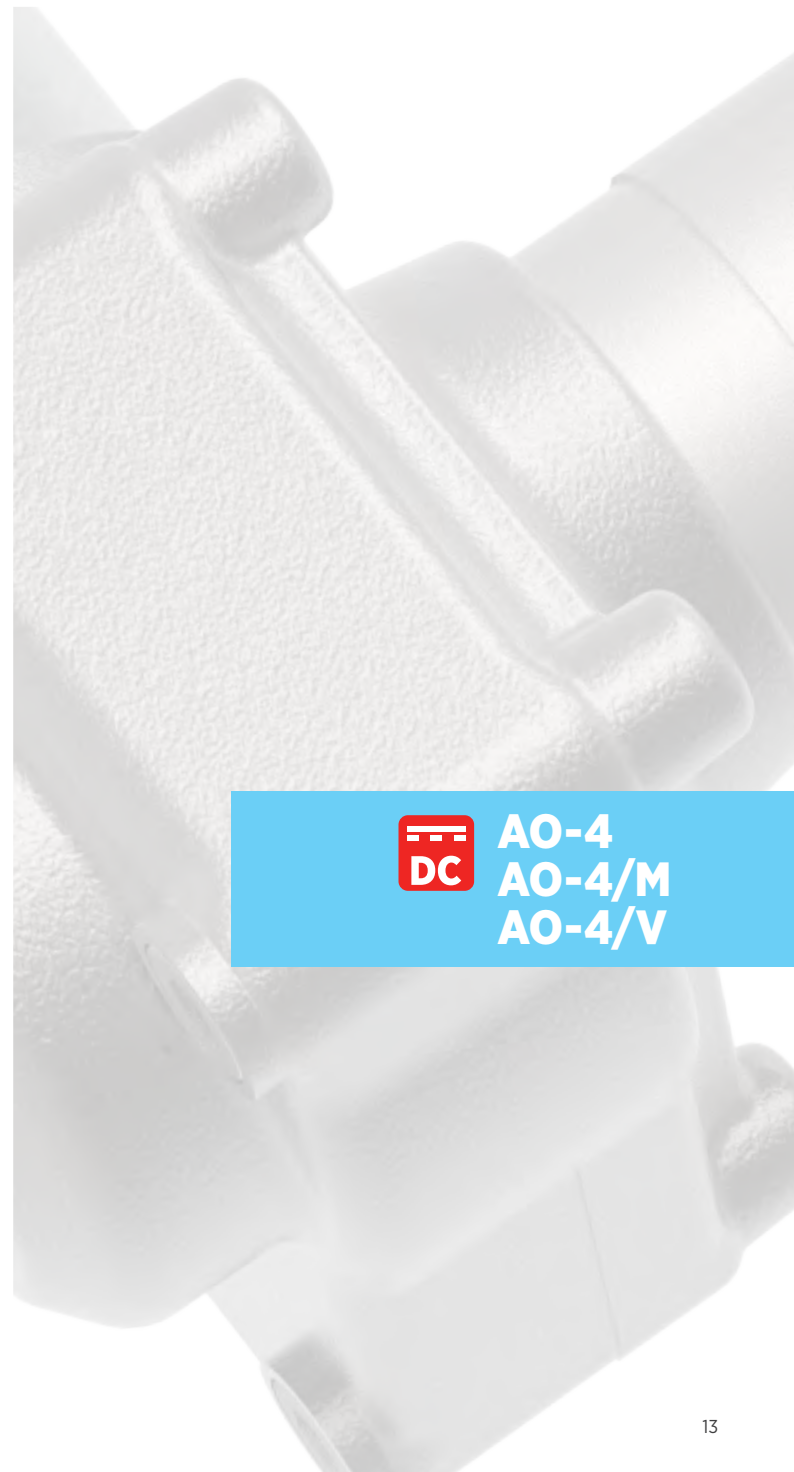

AO-4
AO-4/M
AO-4/V

AO-4

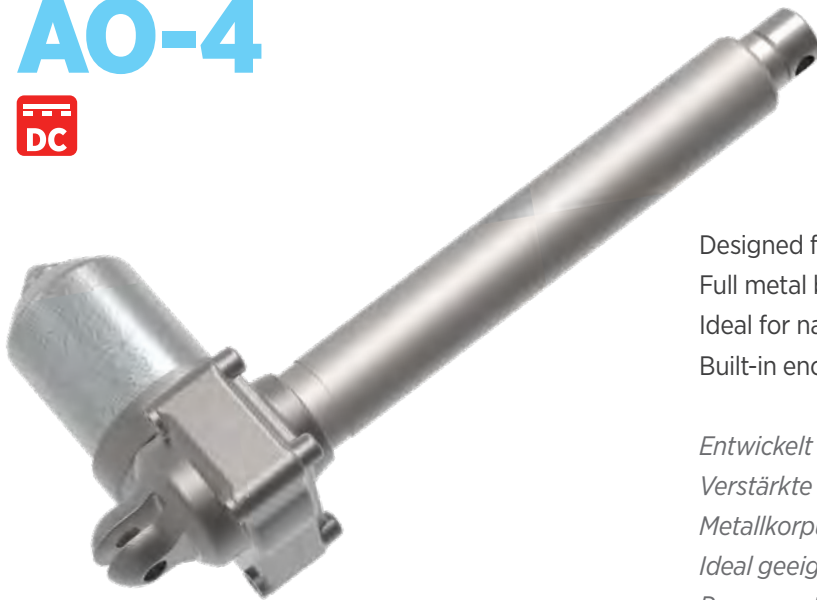

Designed for heavy duty applications thanks to oversized bearings
 Full metal body actuator with stainless steel rod as standard
 Ideal for narrow spaces
 Built-in encoder without affecting the standard overall dimensions

Entwickelt für anspruchsvolle Applikationen

Verstärkte Lager

Metallkorpus mit Kolbenstange in Edelstahl

Ideal geeignet für beengte Einbausituationen

Permanente Lagerückmeldung

Features | Technische Merkmale

DC Motors DC Motoren	12÷24÷36 V
Standard protection Schutzart	IP44
Duty cycle Einschaltdauer	S3 10% based on 10 min. S3 10% basierend auf 10 min.
Operating temperature Betriebstemperatur	-10C° ÷ +60C°

Options | Optionen

Encoder | Permanente, digitale Lagerückmeldung

Increased IP | Erhöhte Schutzart

Customizable stroke and retracted length | Kundenspezifische Hübe und eingefahrene Längen

Various rear and front attachments available (0° and 90°) | Befestigungsaugen in 0° und 90° Ausführung

Max thrust Push/Pull [N] Max Kraft Druck / Zug	Max speed [mm/s] Max Geschw.	Stroke length [mm] Hublänge	Installation dim. [mm] Einbaulänge (D)
6000	3	50÷300*	stroke/Hub + 114
5000	5		
4000	9		
3000	13		
1500	26		

*Longer stroke available upon request | Längere Hübe auf Anfrage möglich

Speed vs. Load | Geschwindigkeit / Kraft

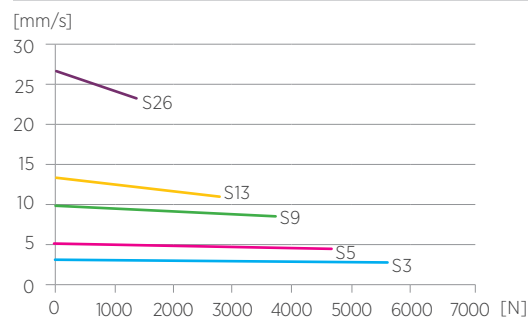

Current vs. Load | Stromaufnahme / Kraft

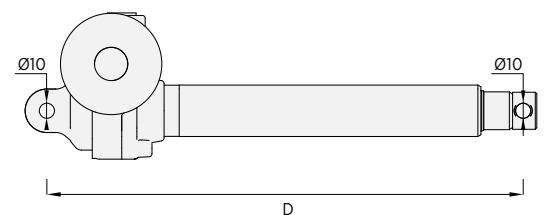
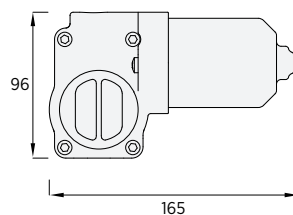
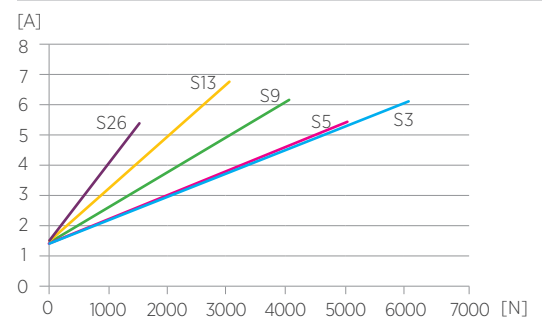

AO-4/M



Designed for heavy duty applications thanks to oversized bearings

Full metal body actuator with stainless steel rod as standard

Integrated and adjustable end-stroke limit switches

Built-in encoder without affecting the standard overall dimensions

Entwickelt für anspruchsvolle Applikationen

Verstärkte Lager

Metallkorpus mit Kolbenstange in Edelstahl

Integrierte und einstellbare Endschalter

Permanente Lagerückmeldung



Features | Technische Merkmale

DC Motors DC Motoren	12÷24÷36 V
Standard protection Schutzart	IP44
Duty cycle Einschaltdauer	S3 10% based on 10 min. S3 10% basierend auf 10 min.
Operating temperature Betriebstemperatur	-10C° ÷ +60C°

Options | Optionen

Encoder Permanente, digitale Lagerückmeldung
Anti rotation Verdrehgesicherte Kolbenstange
Increased IP Erhöhte Schutzart
Customizable stroke and retracted length Kundenspezifische Hübe und eingefahrene Längen
Various rear and front attachments available (0° and 90°) Befestigungsaugen in 0° und 90° Ausführung

Max thrust Push/Pull [N] Max Kraft Druck / Zug	Max speed [mm/s] Max Geschw.	Stroke length [mm] Hublänge	Installation dim. [mm] Einbaulänge (D)
6000	3	50÷300*	stroke/Hub + 122
5000	5		
4000	9		
3000	13		
1500	26		

*Longer stroke available upon request | Längere Hübe auf Anfrage möglich

Speed vs. Load | Geschwindigkeit / Kraft

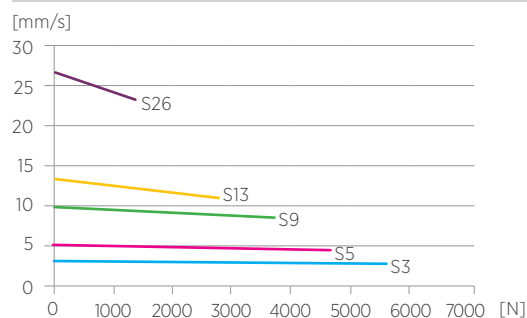

Current vs. Load | Stromaufnahme / Kraft

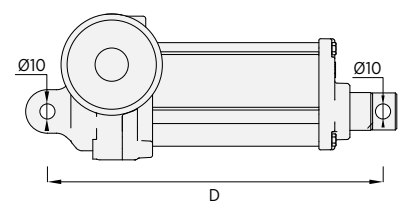
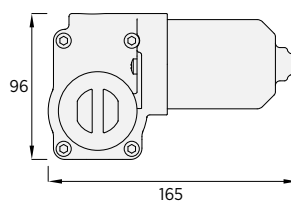
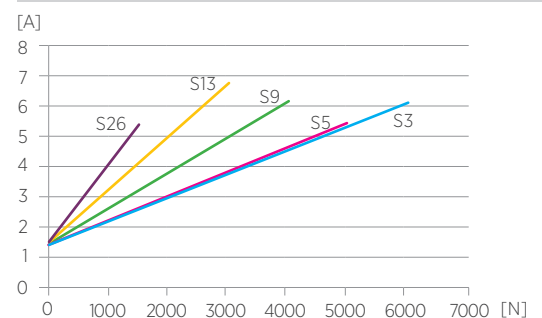

AO-4/V



Designed for heavy duty applications thanks to oversized bearings
 Minimum overall building dimension
 Customizable screw bar and gear ratio
 Customer based design nut
 Full metal body actuator

*Entwickelt für anspruchsvolle Applikationen Verstärkte Lager
 Minimalste Einbaumaße
 Kundenspezifische Leistungsübersetzungen
 Applikationsspezifische Tragmutter
 Metallkorp*

Features | Technische Merkmale

DC Motors DC Motoren	12÷24÷36 V
Built-in nut Tragmutter im Lieferumfang	
Duty cycle Einschaltdauer	S3 10% based on 10 min. S3 10% basierend auf 10 min.
Operating temperature Betriebstemperatur	-10C° ÷ +60C°

Options | Optionen

Encoder Permanente, digitale Lagerückmeldung
Customizable nut and stroke Kundenspezifische Tragmutter - Ausführung
Various rear attachments available (0° and 90°) Hintere Befestigung in 0° und 90° verfügbar

Max thrust Push/Pull [N] Max Kraft Druck / Zug	Max speed [mm/s] Max Geschw.	Stroke length [mm] Hublänge	Installation dim. [mm] Einbaulänge (D)
6000	3	50÷300*	stroke/Hub + 90
5000	5		
4000	9		
3000	13		
1500	26		

*Longer stroke available upon request | Längere Hübe auf Anfrage möglich

Speed vs. Load | Geschwindigkeit / Kraft

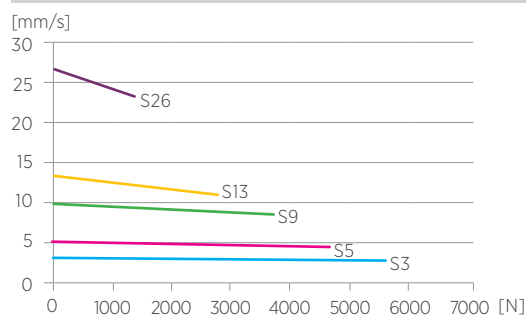

Current vs. Load | Stromaufnahme / Kraft

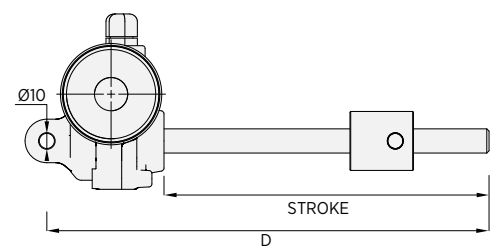
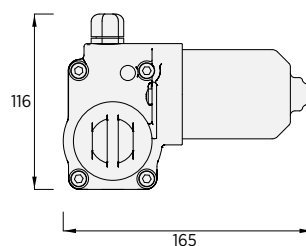
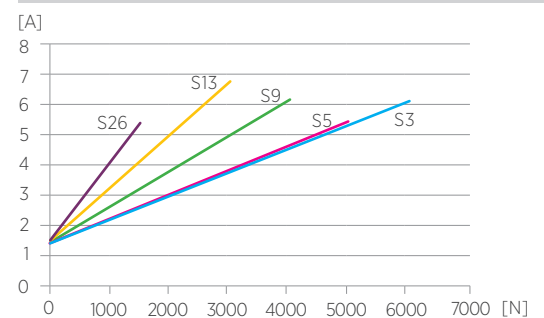

XL LINE

The right choice to operate under harsh
and rugged conditions.
Up to 10.000N.

*Die richtige Wahl für den Einsatz unter
rauhem Umgebungsbedingungen.
Leistungen bis 10.000N.*



 **AO-6/M**
AO-36/M

 **AO-3**
AO-36/M

AO-6/M



- High IP protection
- Built-in breathing valve to avoid internal condensation
- Full metal body actuator with stainless steel rod as standard
- All metal components are galvanic protected
- Integrated and adjustable reed limit switches
- Built-in encoder without affecting the standard overall dimensions

- Hohe Schutzart*
- Integrierte Membran zur Kondensatvermeidung*
- Metallkorpus mit Kolbenstange in Edelstahl*
- Metallteile galvanisch geschützt*
- Integrierte und einstellbare Reed - Schalter*
- Permanente Lagerückmeldung*



Features | Technische Merkmale

DC Motors DC Motoren	12÷24÷36 V
Standard protection Schutzart	IP65
Duty cycle Einschaltdauer	S3 10% based on 10 min. S3 10% basierend auf 10 min.
Operating temperature Betriebstemperatur	-10C° ÷ +60C°

Options | Optionen

- Encoder | Permanente, digitale Lagerückmeldung
- Customizable stroke and retracted length | Kundenspezifische Hübe und eingefahrene Längen
- Various rear and front attachment available (0° and 90°) | Befestigungsaugen in 0° und 90° Ausführung
- Right or Left-hand motor mounting position available | Motorposition links und rechts verfügbar

Max thrust Push/Pull [N] Max Kraft Druck / Zug	Max speed [mm/s] Max Geschw.	Stroke length [mm] Hublänge	Installation dim. [mm] Einbaulänge (D)
6000	3	50÷300*	stroke/Hub + 124
6000	5		
4000	9		
3000	13		
1500	26		

*Longer stroke available upon request | Längere Hübe auf Anfrage möglich

Speed vs. Load | Geschwindigkeit / Kraft

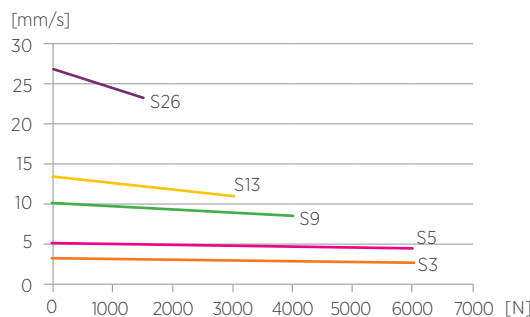

Current vs. Load | Stromaufnahme / Kraft

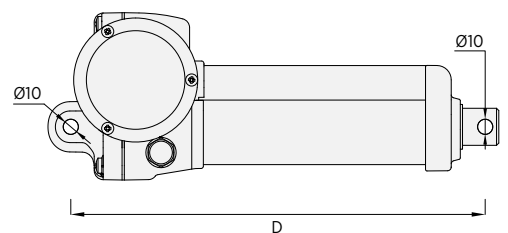
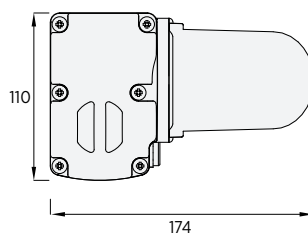
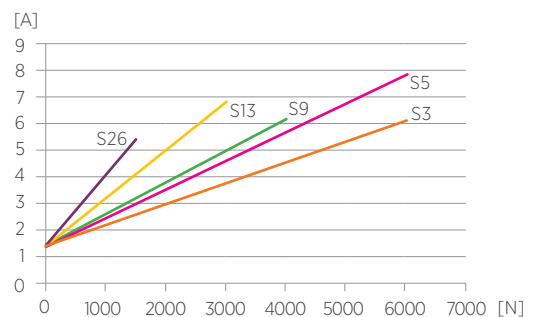

AO-36/M



Designed for heavy duty applications thanks to oversized power transmission

High IP protection

Built-in breathing valve to avoid internal condensation

Full metal body actuator with stainless steel rod as standard

All metal components are galvanic protected

Integrated and adjustable reed limit switches

Built-in encoder without affecting the standard overall dimensions

- Enwickelt für extrem anspruchsvolle Applikationen*
- Verstärktes Hochleistungsgetriebe*
- Hohe Schutzart*
- Integrierte Membran zur Kondensatvermeidung*
- Metallkorpus mit Kolbenstange in Edelstahl*
- Metallteile galvanisch geschützt*
- Integrierte und einstellbare Reed - Schalter*
- Permanente Lagerückmeldung*

Features | Technische Merkmale

DC Motors DC Motoren	12÷24÷36 V
Standard protection Schutzart	IP65
Duty cycle Einschaltdauer	S3 10% based on 10 min. S3 10% basiert auf 10 min.
Operating temperature Betriebstemperatur	-10C° ÷ +60C°

Options | Optionen

- Encoder | Permanente, digitale Lagerückmeldung
- Customizable stroke and retracted length | Kundenspezifische Hübe und eingefahrene Längen
- Various rear and front attachments available (0° and 90°) | Befestigungsaugen in 0° und 90° Ausführung

Max thrust Push/Pull [N] Max Kraft Druck / Zug	Max speed [mm/s] Max Geschw.	Stroke length [mm] Hublänge	Installation dim. [mm] Einbaulänge (D)
10000	4	50÷300*	stroke/Hub + 160
8000	7		stroke/Hub + 136
6000	14		

*Longer stroke available upon request | Längere Hübe auf Anfrage möglich

Speed vs. Load | Geschwindigkeit / Kraft

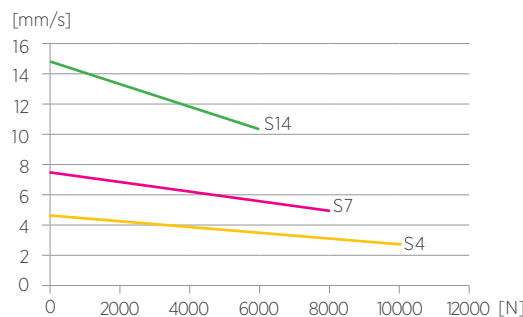

Current vs. Load | Stromaufnahme / Kraft

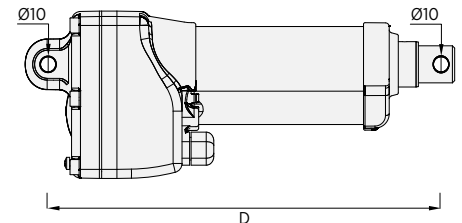
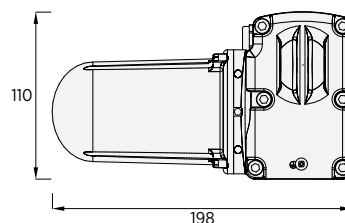
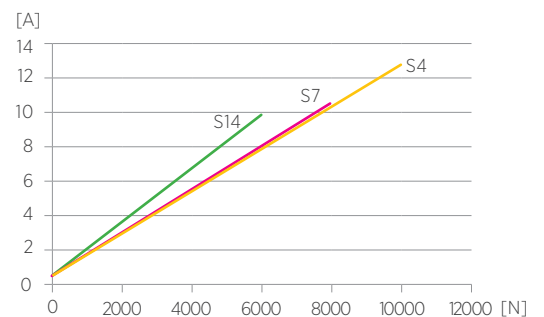

AO-3



- High-speed
- Compact, own-design motor
- Integrated and adjustable reed limit switches
- Right or Left-hand motor mounting position available

*Hochleistungs AC - Kompaktmotor
Integrierte und einstellbare Reed - Schalter
Motorposition links und rechts verfügbar*

Features | Technische Merkmale

AC Motors AC Motoren	Single-phase 230V 50Hz 230V AC, 50hz, 1Ph.
Aluminium rod Alu Kolbenstange	
Standard protection Schutzart	IP65
Duty cycle Einschaltdauer	S3 10% based on 10 min. S3 10% basierend auf 10 min.
Operating temperature Betriebstemperatur	-10C° ÷ +60C°

Options | Optionen

Customizable stroke and retracted length | Kundenspezifische Hübe und eingefahrene Längen
Various rear and front attachments available (0° and 90°) | Befestigungsaugen in 0° und 90° Ausführung

Max thrust Push/Pull [N] Max Kraft Druck / Zug	Max speed [mm/s] Max Geschw.	Stroke length [mm] Hublänge	Installation dim. [mm] Einbaulänge (D)
6000	1	50÷300*	stroke/Hub + 225
6000	7		
4000	14		

*Longer stroke available upon request | Längere Hübe auf Anfrage möglich

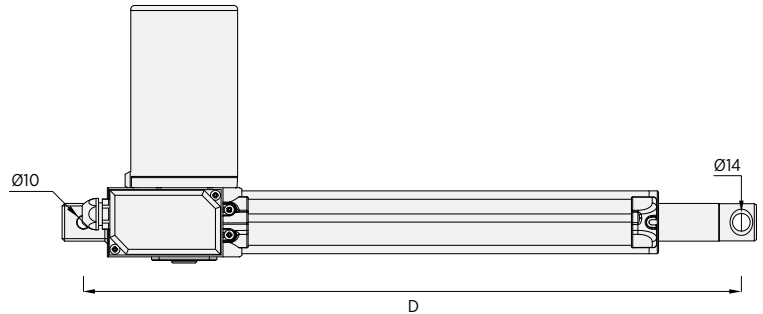
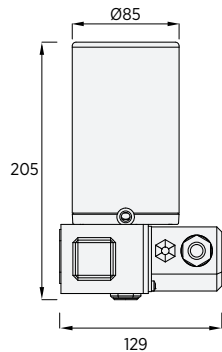

AO-36/M



Heavy duty actuator with a oversized power transmission
 High IP protection and built-in breathing valve
 Full metal body actuator with stainless steel rod as standard
 All metal components are galvanic protected
 Integrated and adjustable reed-type limit switches

Hochleistungs AC - Kompaktmotor
Verstärktes Hochleistungsgetriebe
Hohe Schutzart
Integrierte Membran zur Kondensatvermeidung
Metallkorpus mit Kolbenstange in Edelstahl
Metallteile galvanisch geschützt
Integrierte und einstellbare Reed - Schalter

Features | Technische Merkmale

AC Motors AC Motoren	Single-phase 230V 50Hz 230V AC, 50hz, 1Ph.
Standard protection Schutzart	IP65
Duty cycle Einschaltdauer	S3 10% based on 10 min. S3 10% basiert auf 10 min.
Operating temperature Betriebstemperatur	-10C° ÷ +60C°

Options | Optionen

Encoder | *Permanente, digitale Lagerückmeldung*
 Customizable stroke and retracted length | *Kundenspezifische Hübe und eingefahrene Längen*
 Various rear and front attachments available (0° and 90°) | *Befestigungsaugen in 0° und 90° Ausführung*

Max thrust Push/Pull [N] Max Kraft Druck / Zug	Max speed [mm/s] Max Geschw.	Stroke length [mm] Hublänge	Installation dim. [mm] Einbaulänge (D)
8000	1	100÷400*	stroke/Hub + 136
8000	1,5		
6000	3,5		
6000	5,5		

*Longer stroke available upon request | *Längere Hübe auf Anfrage möglich*

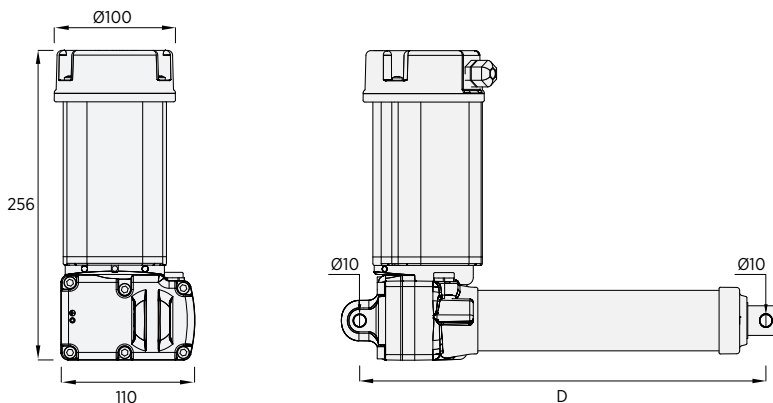

XXXI LINE

The perfect product family for solutions in tough industrial and agriculture conditions.
Up to 15.000N.

*Die perfekte Produktgruppe für Lösungen von anspruchsvollen Anforderungen in Industrie- und Agrarapplikationen.
Bis zu 15.000N.*



AP-150/M

AP-150/M



High quality actuator for industrial and agriculture machines
 Best efficiency available
 Designed to work under tough and extreme conditions
 Force up to 15.000N, Speed up to 90 mm/sec.,
 Stroke up to 1.000mm

Hochwertiger Antrieb für Industrie- und Landwirtschaftsmaschinen
Höchste verfügbare Effizienzklasse
Entwickelt für härteste und extremste Bedingungen
Verstellkraft bis zu 15.000N, Geschwindigkeit bis zu 90 mm/sec., Hublängen bis zu 1.000mm

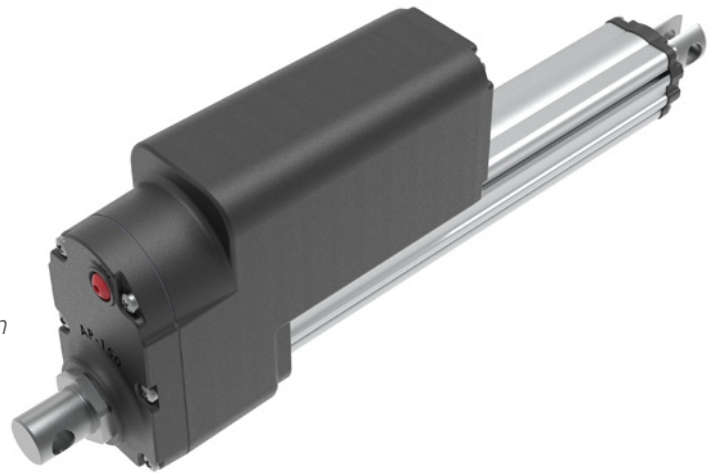

Manual (emergency) activation
 Manuelle (Not-) Betätigung

Features | Technische Merkmale

DC Motors DC Motoren	12÷24÷36 V
Stainless steel rod Kolbenstange in Ebelstahl	
Standard protection Schutzart	IP65
Operation temperature Betriebstemperatur	-20C° ÷ +60C°

Options | Optionen

CAN BUS controller integrated CAN-BUS-Controller integriert
Anodized Housing for extreme environments up to IP69K Eloxiertes Gehäuse für extreme Umgebungen bis IP69K
Several contactless analogue & digital Feedback Verschiedene kontaktlose analoge und digitale Lagerückmeldungen
Operating Controller integrated Integrierte Antriebsteuerung
Electrical overload protection Elektrischer Überlastschutz
Manual (emergency) activation Manuelle (Not-) Betätigung

Max thrust Push/Pull [N] Max Kraft Druck / Zug	Max speed [mm/s] Max Geschw.	Stroke length [mm] Hublänge	Installation dim. [mm] Einbaulänge (D)
15.000	4	50÷1000	stroke/Hub < 301 + 210mm stroke/Hub < 301 + 200mm extra reduce stroke/Hub > 300 + 250mm
13.000	6		
10.000	10		
7.000	17		
4.000	22		
3.500	29		
2.500	43		
1.000	86		

Speed vs. Load | Geschwindigkeit / Kraft

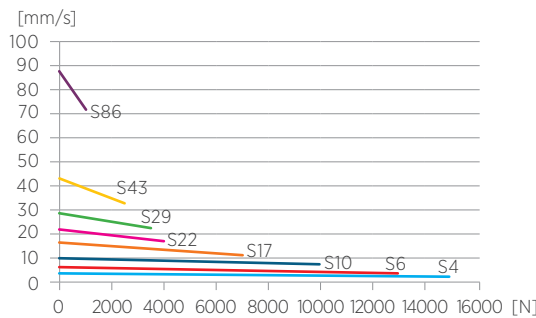

Current vs. Load | Stromaufnahme / Kraft

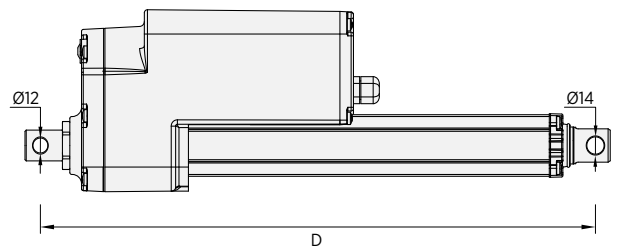
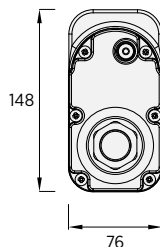
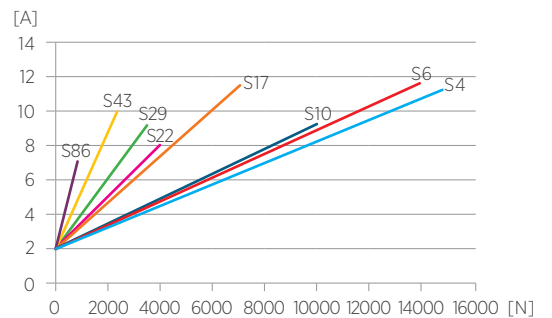

SIGARO LINE

The thinnest solution for linear motion applications.
Up to 3.000N.

Die filigrane Lösung für Applikationen im Bereich der elektrischen Antriebstechnik. Leistungen bis 3.000N.



AL-01
AL-01/M
AL-3
AL-3/M

AL-01

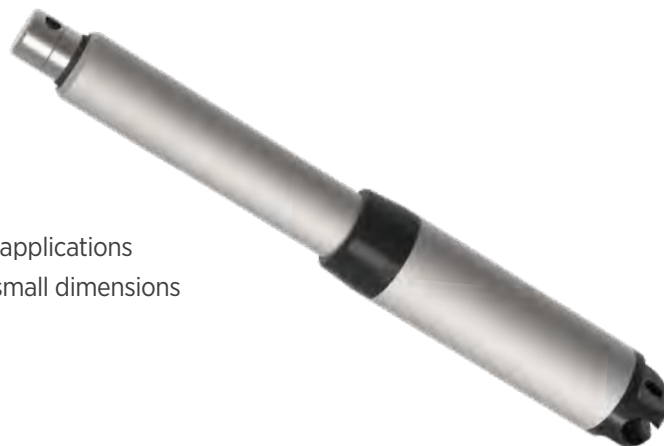

Just 35mm body diameter
 Smooth design ideal for in-view applications
 High performances despite the small dimensions

*Nur 35 mm Außendurchmesser
 Optisch ansprechendes Design
 Ideal für sichtbare Applikationen
 Höchste Leistungen trotz kleinster Dimensionen*

Features | Technische Merkmale

DC Motors DC Motoren	12÷24÷36 V
Aluminium rod Alu Kolbenstange	
Standard protection Schutzart	IP44
Duty cycle Einschaltdauer	S3 10% based on 10 min. S3 10% basierend auf 10 min.
Operating temperature Betriebstemperatur	-10C° ÷ +60C°

Options | Optionen

Encoder Permanente, digitale Lagerückmeldung
Stainless steel rod Kolbenstange in Edelstahl
Increased IP Erhöhte Schutzart
Customizable stroke and retracted length Kundenspezifische Hübe und eingefahrene Längen

Max thrust Push/Pull [N] Max Kraft Druck / Zug	Max speed [mm/s] Max Geschw.	Stroke length [mm] Hublänge	Installation dim. [mm] Einbaulänge (D)
1500	6	50÷300*	stroke/Hub + 157
800	13		stroke/Hub + 157
1500	10		stroke/Hub + 167

*Longer stroke available upon request | Längere Hübe auf Anfrage möglich

Speed vs. Load | Geschwindigkeit / Kraft

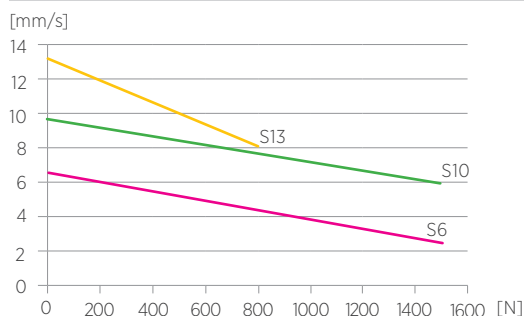

Current vs. Load | Stromaufnahme / Kraft

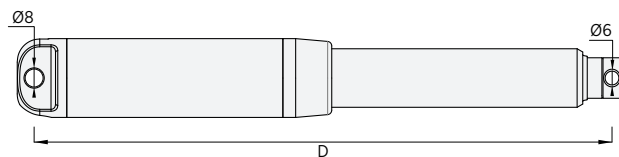
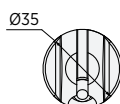
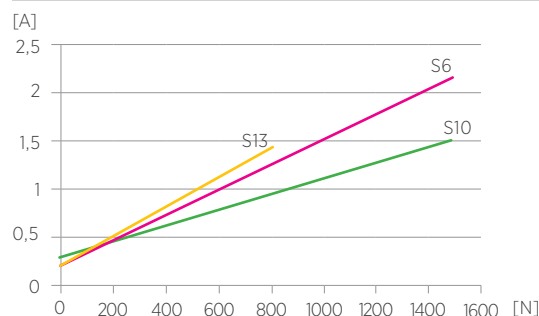

AL-01/M



Thin in-line actuator with integrated and adjustable end-stroke limit switches
 Smooth design ideal for in-view applications
 High performances despite the small dimensions

Schmaler In-Line Linearantrieb mit Integrierten und einstellbaren Endschaltern

Optisch ansprechendes Design

Ideal für sichtbare Applikationen

Höchste Leistungen trotz kompakter Dimensionen

Features | Technische Merkmale

DC Motors DC Motoren	12÷24÷36 V
Aluminium rod Alu Kolbenstange	
Standard protection Schutzart	IP44
Duty cycle Einschaltdauer	S3 10% based on 10 min. S3 10% basierend auf 10 min.
Operating temperature Betriebstemperatur	-10C° ÷ +60C°

Options | Optionen

Encoder Permanente, digitale Lagerückmeldung
Stainless steel rod Kolbenstange in Edelstahl
Increased IP Erhöhte Schutzart
Customizable stroke and retracted length Kundenspezifische Hübe und eingefahrene Längen

Max thrust Push/Pull [N] Max Kraft Druck / Zug	Max speed [mm/s] Max Geschw.	Stroke length [mm] Hublänge	Installation dim. [mm] Einbaulänge (D)
1500	6	50÷300*	stroke/Hub + 186
800	13		

*Longer stroke available upon request | Längere Hübe auf Anfrage möglich

Speed vs. Load | Geschwindigkeit / Kraft

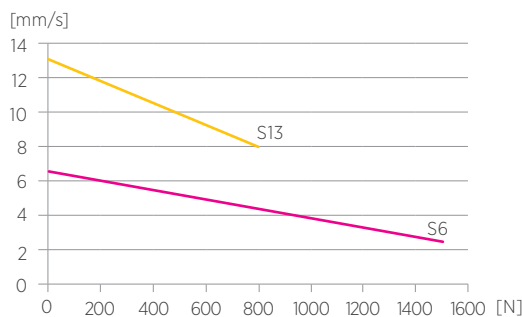

Current vs. Load | Stromaufnahme / Kraft

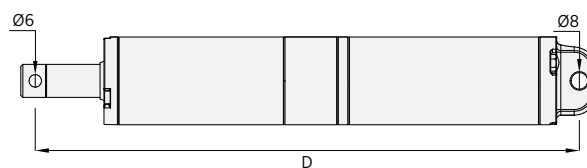
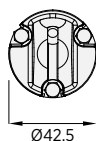
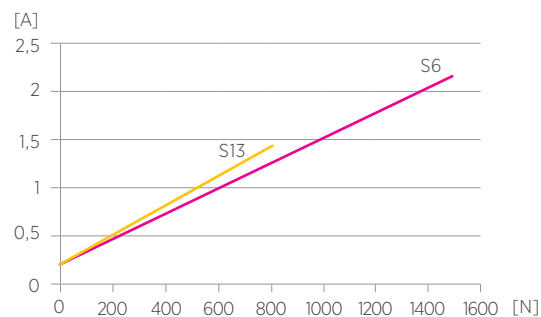

AL-3



Just 50mm body diameter
Aesthetically pleasant design for in-view applications
High performance, full metal body actuator

Nur 50 mm Durchmesser
Optisch ansprechendes Design
Ideal für sichtbare Applikationen
Hohe Leistungen trotz kompakter Dimensionen
Gehäuse in Metallausführung

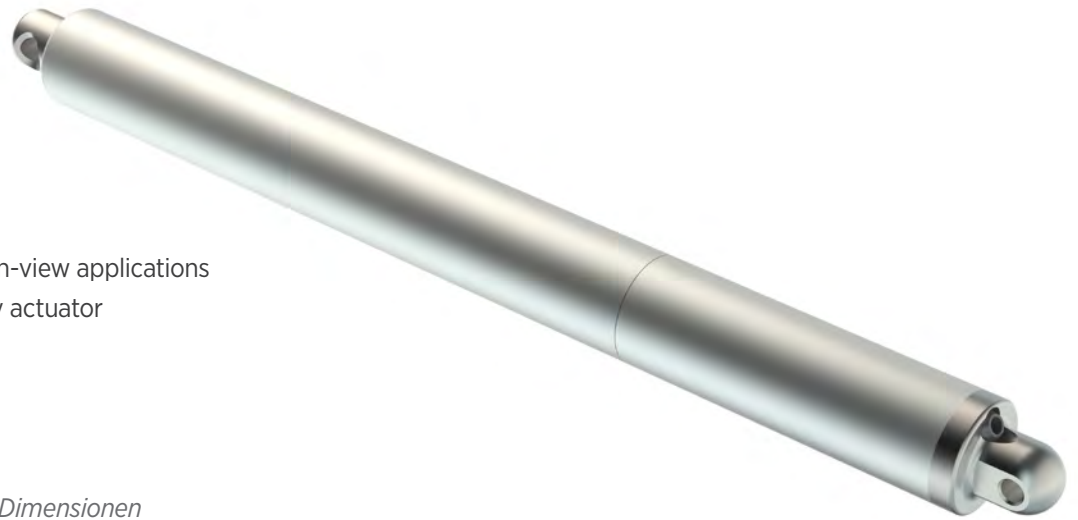

Features Technische Merkmale	
DC Motors DC Motoren	12÷24÷36 V
Aluminium rod Alu Kolbenstange	
Standard protection Schutzart	IP44
Duty cycle Einschaltdauer	S3 10% based on 10 min. S3 10% basierend auf 10 min.
Operating temperature Betriebstemperatur	-10C° ÷ +60C°

Options Optionen	
Encoder Permanente, digitale Lagerückmeldung	
Stainless steel rod Kolbenstange in Edelstahl	
Increased IP Erhöhte Schutzart	
Customizable stroke and retracted length Kundenspezifische Hübe und eingefahrene Längen	

Max thrust Push/Pull [N] Max Kraft Druck / Zug	Max speed [mm/s] Max Geschw.	Stroke length [mm] Hublänge	Installation dim. [mm] Einbaulänge (D)
3000	9	50÷300*	stroke/Hub + 248
2000	18		

*Longer stroke available upon request | Längere Hübe auf Anfrage möglich

Speed vs. Load | Geschwindigkeit / Kraft

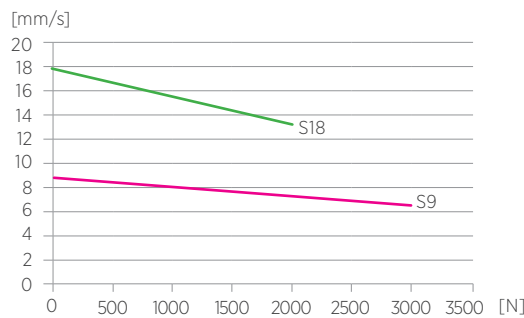

Current vs. Load | Stromaufnahme / Kraft

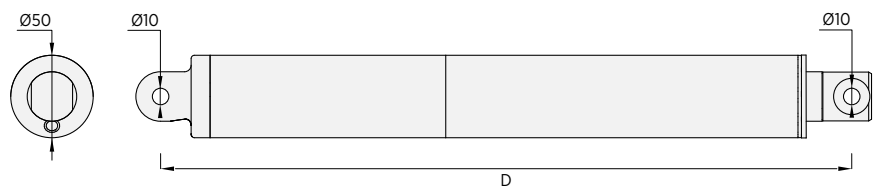
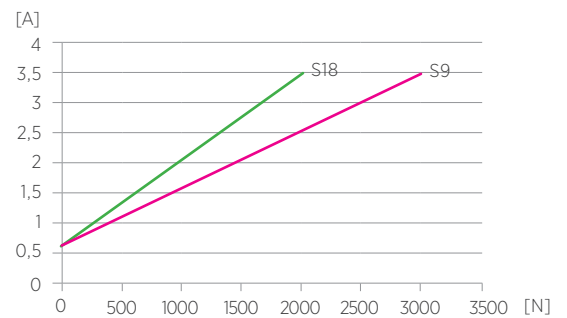

AL-3/M



Integrated and adjustable reed limit switches
 Smooth design ideal for in-view applications
 High performances despite the small dimensions
 Full metal body actuator



*Interierte und einstellbare Endschalter
 Optisch ansprechendes Design
 Ideal für sichtbare Applikationen
 Hohe Leistungen trotz kompakter Dimensionen
 Gehäuse in Metallausführung*

Features | Technische Merkmale

DC Motors DC Motoren	12÷24÷36 V
Aluminium rod Alu Kolbenstange	
Standard protection Schutzart	IP44
Duty cycle Einschaltdauer	S3 10% based on 10 min. S3 10% basierend auf 10 min.
Operating temperature Betriebstemperatur	-10C° ÷ +60C°

Options | Optionen

Encoder Permanente, digitale Lagerückmeldung
Stainless steel rod Kolbenstange in Edelstahl
Increased IP Erhöhte Schutzart
Customizable stroke and retracted length Kundenspezifische Hübe und eingefahrene Längen

Max thrust Push/Pull [N] Max Kraft Druck / Zug	Max speed [mm/s] Max Geschw.	Stroke length [mm] Hublänge	Installation dim. [mm] Einbaulänge (D)
3000	9	50÷300*	stroke/Hub + 265
2000	18		

*Longer stroke available upon request | Längere Hübe auf Anfrage möglich

Speed vs. Load | Geschwindigkeit / Kraft

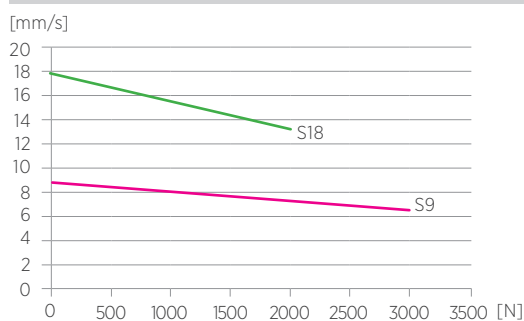

Current vs. Load | Stromaufnahme / Kraft

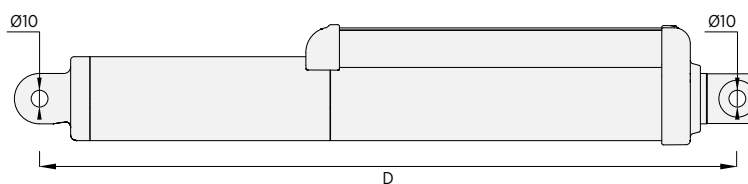
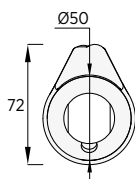
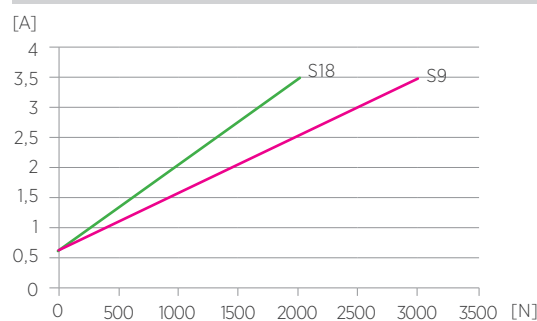

COMPACT LINE

Parallel-axis actuator family with optimized installation dimensions. Up to 3.500N.

Die Antriebsfamilie mit den optimalen Einbaumaßen durch parallel angeordnete Bauteile. Leistungen bis 3.500N.



AOP-1/M
AOP-1/Mi
AOP-1/M agri
AOP-1/Mt
AOP-2/M
AOP-2/Mi
AOP-2/M agri

AOP-1/M



- Extra slim dimension
- Full metal body
- Multiple Gearing solutions
- Integrated end-stroke limit switches

- Äußerst kompakte Abmessungen
- Metallgehäuse
- Umfangreiche Getriebevarianten verfügbar
- Integrierte Endschalter

Features | Technische Merkmale

DC Motors DC Motoren	12÷24÷36 V
Aluminium rod Alu Kolbenstange	
Standard protection Schutzart	IP44
Duty cycle Einschaltdauer	S3 10% based on 10 min. S3 10% basierend auf 10 min.
Operating temperature Betriebstemperatur	-20C° ÷ +60C°

Options | Optionen

Stainless steel rod Kolbenstange in Edelstahl
Anti rotation Verdrehgesicherte Kolbenstange
Increased protection up to IP69K Erhöhte Schutzart bis IP69K
Customizable stroke and retracted length Kundenspezifische Hübe und eingefahrene Längen
Various rear and front attachment available (0° and 90°) Befestigungsaugen in 0° und 90° Ausführung

Max thrust Push/Pull [N] Max Kraft Druck / Zug	Max speed [mm/s] Max Geschw.	Stroke length [mm] Hublänge	Installation dim. [mm] Einbaulänge (D)
1000	6	50÷300*	stroke/Hub + 115
750	12		
500	16		
300	20		
200	40		

*Longer stroke available upon request | Längere Hübe auf Anfrage möglich

Speed vs. Load | Geschwindigkeit / Kraft

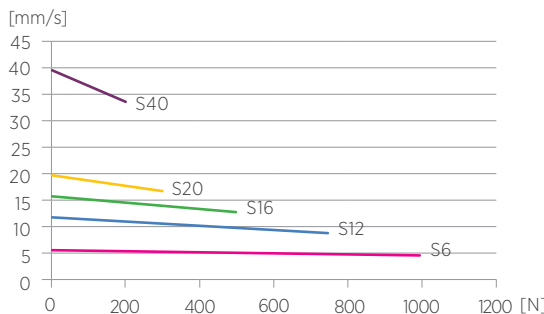

Current vs. Load | Stromaufnahme / Kraft

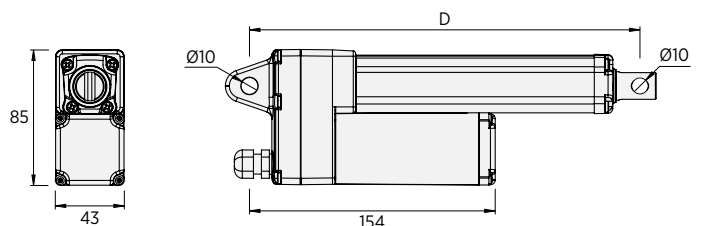
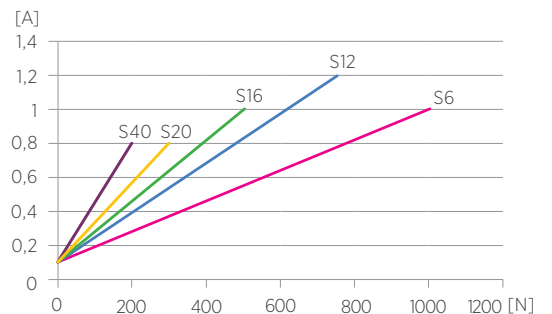

AOP-1/Mi



Extra slim dimension
 Full metal body
 Multiple Gearing solutions
 Several integrated feedback solutions available

Äußerst kompakte Abmessungen
 Metallgehäuse
 Umfangreiche Getriebevarianten verfügbar
 Verschiedene Lagerückmeldungen erhältlich

Features | Technische Merkmale

DC Motors DC Motoren	12÷24÷36 V
Aluminium rod Alu Kolbenstange	
Standard protection Schutzart	IP44
Duty cycle Einschaltdauer	S3 10% based on 10 min. S3 10% basierend auf 10 min.
Operating temperature Betriebstemperatur	-20C° ÷ +60C°
Digital-analog potentiometer or encoder Permanente verschleißfreie analoge oder digitale (Hall - Sensor) Lagerückmeldung	

Options | Optionen

Stainless steel rod Kolbenstange in Edelstahl
Anti rotation Verdrehgesicherte Kolbenstange
Increased protection up to IP69K Erhöhte Schutzart bis IP69K
Customizable stroke and retracted length Kundenspezifische Hübe und eingefahrene Längen
Various rear and front attachment available (0° and 90°) Befestigungsaugen in 0° und 90° Ausführung

Max thrust Push/Pull [N] Max Kraft Druck / Zug	Max speed [mm/s] Max Geschw.	Stroke length [mm] Hublänge	Installation dim. [mm] Einbaulänge (D)
1000	6	50÷300*	stroke/Hub + 115
750	12		
500	16		
300	20		
200	40		

*Longer stroke available upon request | Längere Hübe auf Anfrage möglich

Speed vs. Load | Geschwindigkeit / Kraft

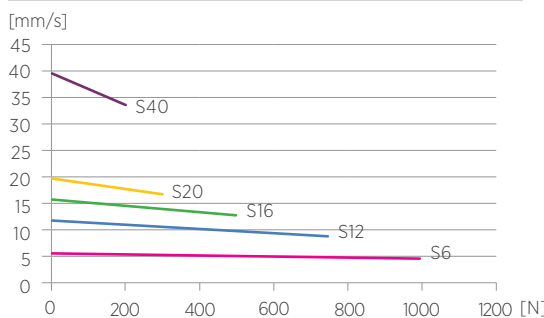

Current vs. Load | Stromaufnahme / Kraft

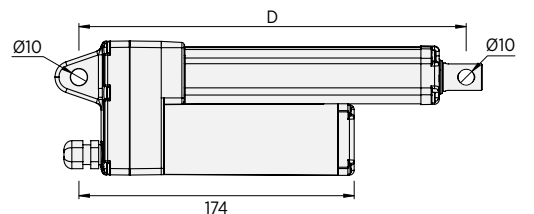
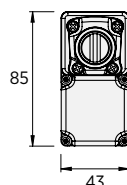
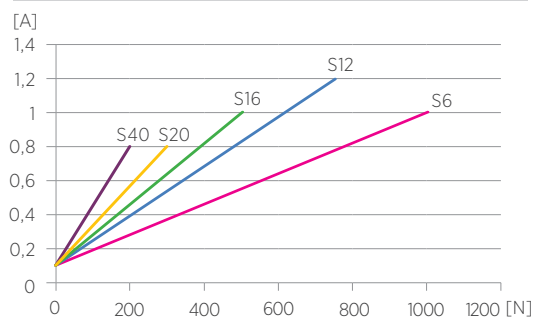

AOP-1/M agri



Compact dimensions
 Special protection to aggressive substances
 Several integrated feedback solutions available
 Integrated end-stroke limit switches

*Kompakte Ausführung
 Spezielle Ausführung für aggressive Medien
 Verschiedene Lagerrückmeldungen erhältlich
 Integrierte Endschalter*

Features | Technische Merkmale

DC Motors DC Motoren	12÷24÷36 V
Stainless steel rod Kolbenstange in Edelstahl	
Standard protection Schutzart	IP69K
Duty cycle Einschaltdauer	S3 10% based on 10 min. S3 10% basierend auf 10 min.
Operating temperature Betriebstemperatur	-20C° ÷ +60C°
Coating against chemical corrosion Spezielle Gehäusebeschichtung zum Schutz vor chemischer Korrosion	
Digital-analog potentiometer or encoder Permanente verschleißfreie analoge oder digitale (Hall - Sensor) Lagerrückmeldung	
Anti rotation Verdrehgesicherte Kolbenstange	

Options | Optionen

Customizable stroke and retracted length | Kundenspezifische Hübe und eingefahrene Längen
 Various rear and front attachment available (0° and 90°) | Befestigungsaugen in 0° und 90° Ausführung

Max thrust Push/Pull [N] Max Kraft Druck / Zug	Max speed [mm/s] Max Geschw.	Stroke length [mm] Hublänge	Installation dim. [mm] Einbaulänge (D)
1000	6	50÷300*	stroke/Hub + 115
750	12		
500	16		
300	20		
200	40		

*Longer stroke available upon request | Längere Hübe auf Anfrage möglich

Speed vs. Load | Geschwindigkeit / Kraft

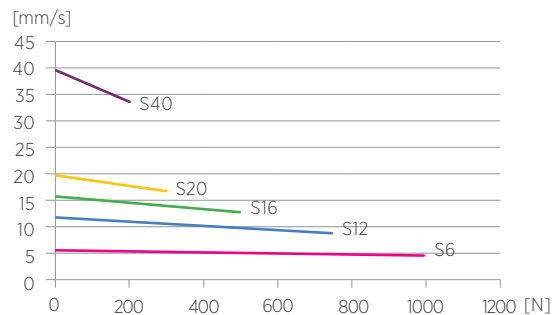

Current vs. Load | Stromaufnahme / Kraft

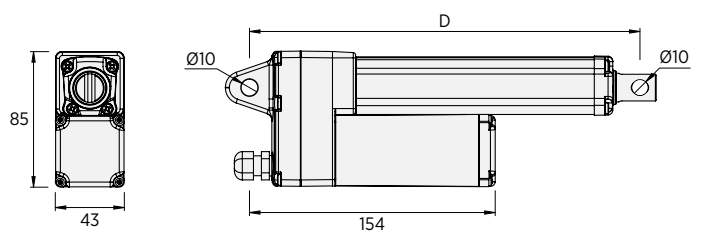
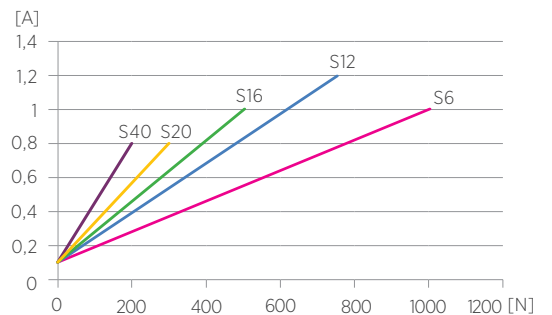

AOP-1/Mt

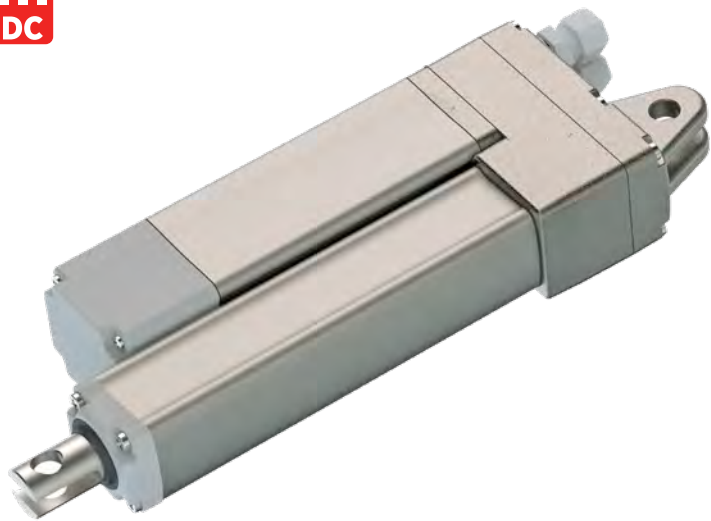

- Extra slim dimension
- Full metal body
- Multiple Gearing solutions
- Plenty place for customized electronics built in

- Sehr kompakte Abmessungen*
- Metallgehäuse*
- Umfangreiche Getriebevarianten verfügbar*
- Integrationsmöglichkeiten für kundenspezifische Elektronik*

Features | Technische Merkmale

DC Motors DC Motoren	12÷24÷36 V
Aluminium rod Alu Kolbenstange	
Standard protection Schutzart	IP44
Duty cycle Einschaltdauer	S3 10% based on 10 min. S3 10% basierend auf 10 min.
Operating temperature Betriebstemperatur	-20C° ÷ +60C°
Customizable aluminium motor housing Kundenspezifische Aluminium - Gehäuselängen	

Options | Optionen

Stainless steel rod Kolbenstange in Edelstahl
Anti rotation Verdrehgesicherte Kolbenstange
Increased protection up to IP69K Erhöhte Schutzart bis IP69K
Customizable stroke and retracted length Kundenspezifische Hübe und eingefahrene Längen
Various rear and front attachment available (0° and 90°) Befestigungsaugen in 0° und 90° Ausführung

Max thrust Push/Pull [N] Max Kraft Druck / Zug	Max speed [mm/s] Max Geschw.	Stroke length [mm] Hublänge	Installation dim. [mm] Einbaulänge (D)
1000	6	50÷300*	stroke/Hub + 115
750	12		
500	16		
300	20		
200	40		

*Longer stroke available upon request | Längere Hübe auf Anfrage möglich

Speed vs. Load | Geschwindigkeit / Kraft

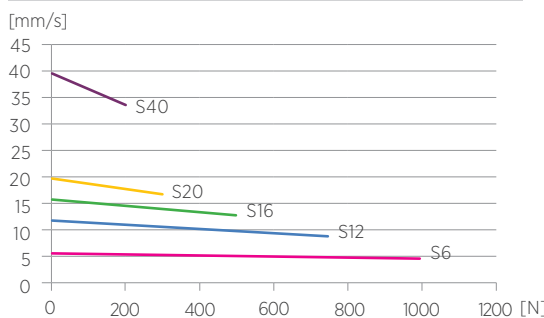

Current vs. Load | Stromaufnahme / Kraft

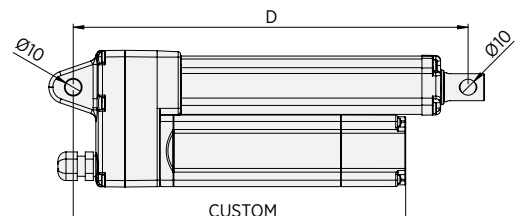
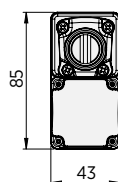
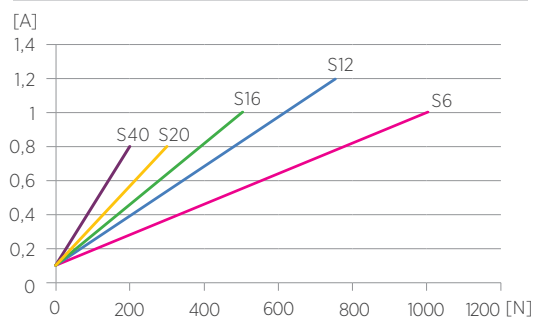

AOP-2/M



Compact dimensions
 Designed for heavy and harsh applications
 Powerful and fast
 Integrated end-stroke limit switches

*Kompakte Ausführung
 Entwickelt für raue und anspruchsvolle Umgebungen
 Leistungsstark und schnell
 Integrierte Endschalter*

Features | Technische Merkmale

DC Motors DC Motoren	12÷24÷36 V
Stainless steel rod Kolbenstange in Edelstahl	
Standard protection Schutzart	IP44
Duty cycle Einschaltdauer	S3 10% based on 10 min. S3 10% basierend auf 10 min.
Operating temperature Betriebstemperatur	-20C° ÷ +60C°

Options | Optionen

Anti rotation Verdrehgesicherte Kolbenstange
Increased protection up to IP69K Erhöhte Schutzart bis IP69K
Customizable stroke and retracted length Kundenspezifische Hübe und eingefahrene Längen
Various rear and front attachment available (0° and 90°) Befestigungsäugen in 0° und 90° Ausführung

Max thrust Push/Pull [N] Max Kraft Druck / Zug	Max speed [mm/s] Max Geschw.	Stroke length [mm] Hublänge	Installation dim. [mm] Einbaulänge (D)
3500	3	50÷300*	stroke/Hub + 123
2500	7		
1500	10		
1000	18		
800	26		
400	35		

*Longer stroke available upon request | Längere Hübe auf Anfrage möglich

Speed vs. Load | Geschwindigkeit / Kraft

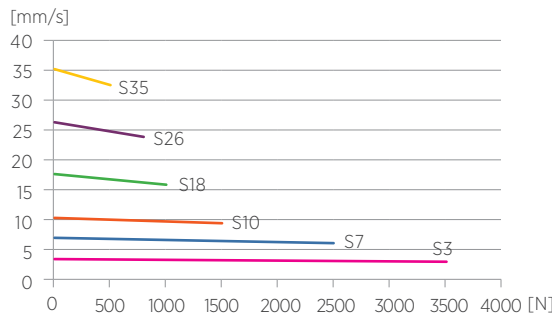

Current vs. Load | Stromaufnahme / Kraft

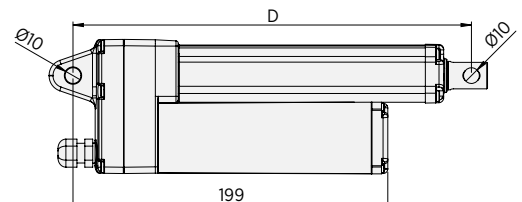
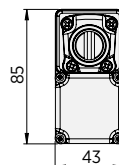
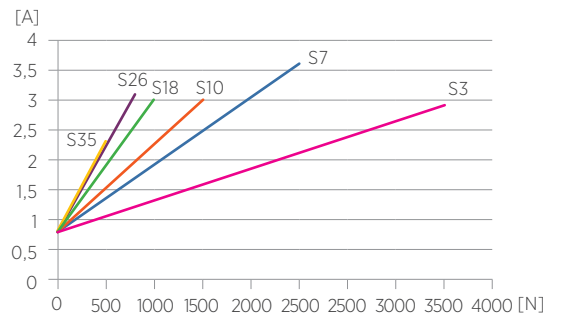

AOP-2/Mi



Compact dimensions
 Designed for heavy and harsh applications
 Powerful and fast
 Several integrated feedback solutions available

*Kompakte Ausführung
 Entwickelt für raue und anspruchsvolle Umgebungen
 Leistungsstark und schnell
 Verschiedene Lagerrückmeldungen erhältlich*

Features | Technische Merkmale

DC Motors DC Motoren	12÷24÷36 V
Stainless steel rod Kolbenstange in Edelstahl	
Standard protection Schutzart	IP44
Duty cycle Einschaltdauer	S3 10% based on 10 min. S3 10% basierend auf 10 min.
Operating temperature Betriebstemperatur	-20C° ÷ +60C°
Digital-analog potentiometer or encoder Permanente verschleißfreie analoge oder digitale (Hall - Sensor) Lagerückmeldung	

Options | Optionen

Anti rotation Verdrehgesicherte Kolbenstange
Increased protection up to IP69K Erhöhte Schutzart bis IP69K
Customizable stroke and retracted length Kundenspezifische Hübe und eingefahrene Längen
Various rear and front attachment available (0° and 90°) Befestigungsäugen in 0° und 90° Ausführung

Max thrust Push/Pull [N] Max Kraft Druck / Zug	Max speed [mm/s] Max Geschw.	Stroke length [mm] Hublänge	Installation dim. [mm] Einbaulänge (D)
3500	3	50÷300*	stroke/Hub + 123
2500	7		
1500	10		
1000	18		
800	26		
400	35		

*Longer stroke available upon request | Längere Hübe auf Anfrage möglich

Speed vs. Load | Geschwindigkeit / Kraft

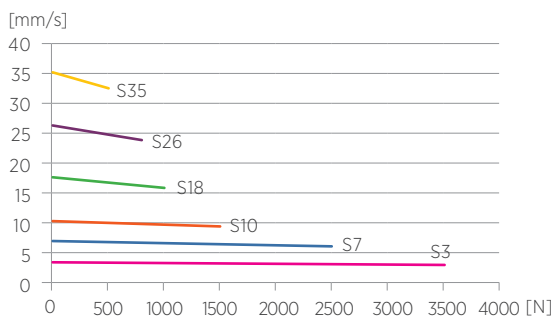

Current vs. Load | Stromaufnahme / Kraft

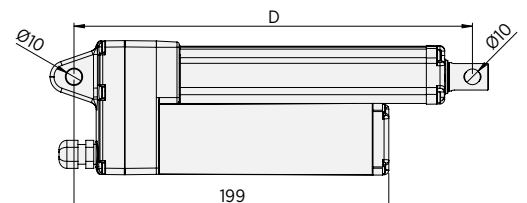
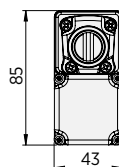
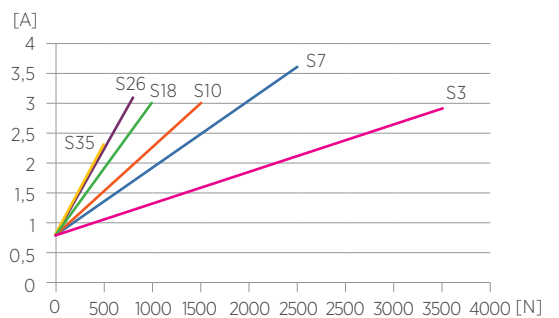

AOP-2/M agri



Compact dimensions
 Special protection to aggressive substances
 Several integrated feedback solutions available
 Integrated end-stroke limit switches

*Kompakte Ausführung
 Spezielle Ausführung für aggressive Medien
 Verschiedene Lagerrückmeldungen erhältlich
 Integrierte Endschalter*

Features | Technische Merkmale

DC Motors DC Motoren	12÷24÷36 V
Stainless steel rod Kolbenstange in Edelstahl	
Standard protection Schutzart	IP69K
Duty cycle Einschaltdauer	S3 10% based on 10 min. S3 10% basierend auf 10 min.
Operating temperature Betriebstemperatur	-20C° ÷ +60C°
Coating against chemical corrosion Spezielle Gehäusebeschichtung zum Schutz vor chemischer Korrosion	
Digital-analog potentiometer or encoder Permanente verschleißfreie analoge oder digitale (Hall - Sensor) Lagerückmeldung	

Options | Optionen

Anti rotation Verdrehgesicherte Kolbenstange
Customizable stroke and retracted length Kundenspezifische Hübe und eingefahrene Längen
Various rear and front attachment available (0° and 90°) Befestigungsaugen in 0° und 90° Ausführung

Max thrust Push/Pull [N] Max Kraft Druck / Zug	Max speed [mm/s] Max Geschw.	Stroke length [mm] Hublänge	Installation dim. [mm] Einbaulänge (D)
3500	3	50÷300*	stroke/Hub + 123
2500	7		
1500	10		
1000	18		
800	26		
400	35		

*Longer stroke available upon request | Längere Hübe auf Anfrage möglich

Speed vs. Load | Geschwindigkeit / Kraft

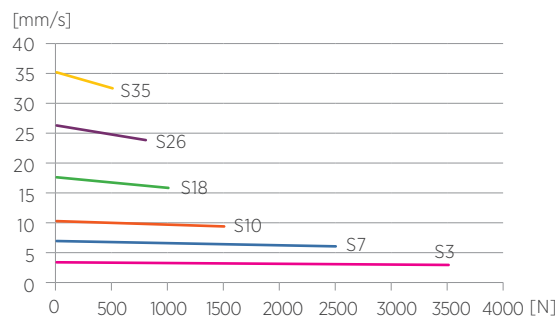

Current vs. Load | Stromaufnahme / Kraft

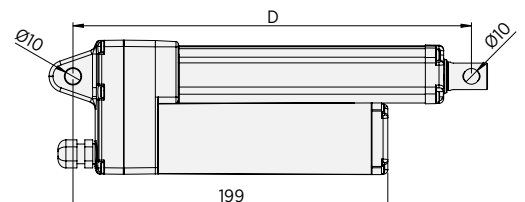
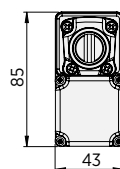
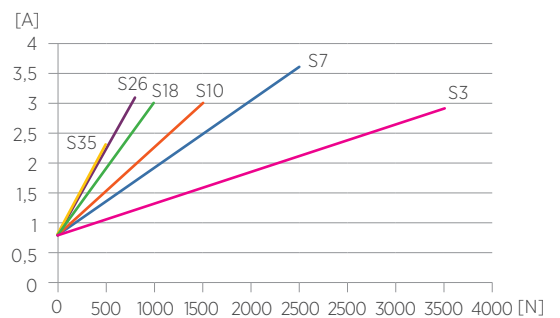

FLEXI LINE

Multi purpose linear actuator family with high efficiency.
Up to 6.500N.

*Multipel einsetzbare und hoch effiziente Antriebsfamilie.
Leistungen bis 6.500N.*



 **AP-3
AP-3/C**

  **AP-3/V**

 **AP-3
AP-3/C**

AP-3



Effective solution designed for mass production needs
 High efficiency power transmission
 Full metal body actuator
 Integrated and adjustable end-stroke limit switches
 Custom design cam setting

Effektive Lösung - speziell entwickelt für die Anforderungen der Großserienfertigung

Hoch effizientes, verstärktes Getriebe

Metallkorpus

Integrierte Endschalter

Kundenspezifische Endschalter - Schaltpunkte

Features | Technische Merkmale

DC Motors DC Motoren	12÷24÷36 V
Standard protection Schutzart	IP44
Duty cycle Einschaltdauer	S3 10% based on 10 min. S3 10% basierend auf 10 min.
Operating temperature Betriebstemperatur	-10C° ÷ +60C°

Options | Optionen

Analog potentiometer or encoder Permanente analoge (Potentiometer) oder digitale (Hall - Sensor) Lagerückmeldung
Customizable stroke and retracted length Kundenspezifische Hübe und eingefahrene Längen
Up to 4 cam-activated switches Bis zu vier Schalter- und positionen verfügbar
Various rear and front attachments available (0° and 90°) Befestigungsaugen in 0° und 90° Ausführung

Max thrust Push/Pull [N] Max Kraft Druck / Zug	Max speed [mm/s] Max Geschw.	Stroke length [mm] Hublänge	Installation dim. [mm] Einbaulänge (D)
4000	11	50÷300*	stroke/Hub + 131
3000	18		
1500	36		

*Longer stroke available upon request | Längere Hübe auf Anfrage möglich

Speed vs. Load | Geschwindigkeit / Kraft

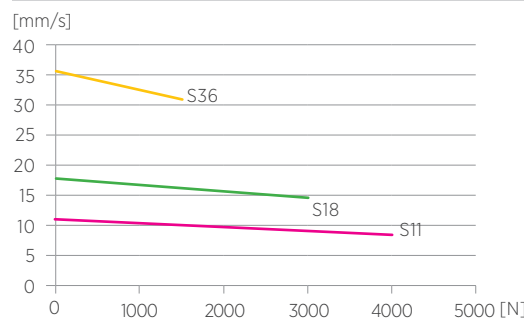

Current vs. Load | Stromaufnahme / Kraft

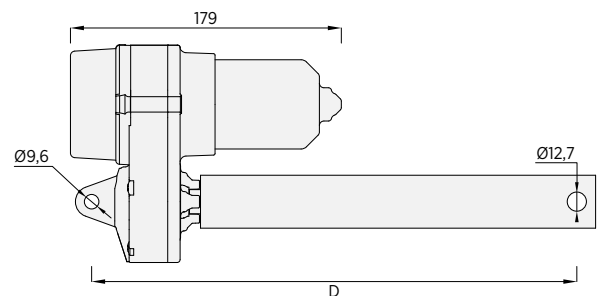
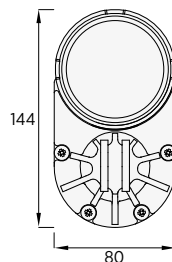
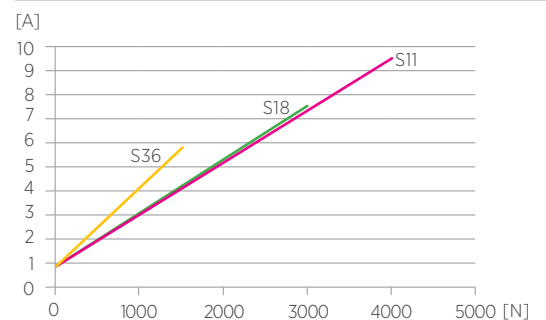

AP-3/C



Improved IP protection for industrial applications

High efficiency power transmission

Full metal body actuator

Integrated and adjustable end-stroke limit switches

Custom design cam setting

Erhöhte Schutzart für industrielle Applikationen

Hoch effizientes, verstärktes Getriebe

Metallkorpus

Integrierte Endschalter

Kundenspezifische Endschalter - Schaltpunkte

Features | Technische Merkmale

DC Motors DC Motoren	12÷24÷36 V
Stainless steel rod Kolbenstange in Edelstahl	
Standard protection Schutzart	IP44
Duty cycle Einschaltdauer	S3 10% based on 10 min. S3 10% basierend auf 10 min.
Operating temperature Betriebstemperatur	-10C° ÷ +60C°

Options | Optionen

Analog potentiometer or encoder Permanente analoge (Potentiometer) oder digitale (Hall - Sensor) Lagerückmeldung
Increased IP Erhöhte Schutzart
Customizable stroke and retracted length Kundenspezifische Hübe und eingefahrene Längen
Up to 4 cam-activated switches Bis zu vier Schalter- und positionen verfügbar
Various rear and front attachments available (0° and 90°) Befestigungsaugen in 0° und 90° Ausführung

Max thrust Push/Pull [N] Max Kraft Druck / Zug	Max speed [mm/s] Max Geschw.	Stroke length [mm] Hublänge	Installation dim. [mm] Einbaulänge (D)
4000	11	50÷300*	stroke/Hub + 102
3000	18		
1500	36		

*Longer stroke available upon request | Längere Hübe auf Anfrage möglich

Speed vs. Load | Geschwindigkeit / Kraft

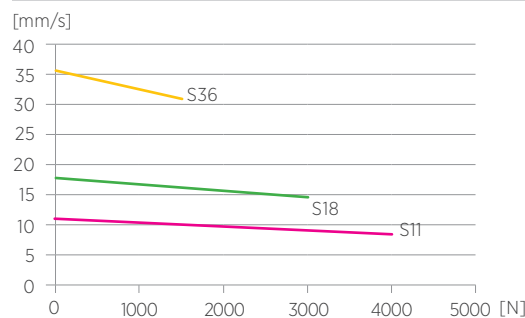

Current vs. Load | Stromaufnahme / Kraft

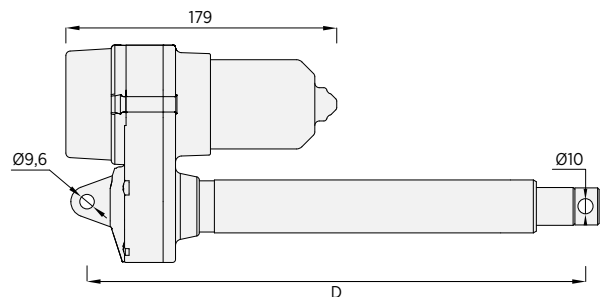
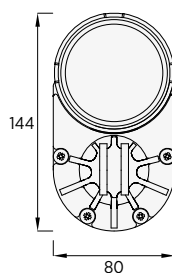
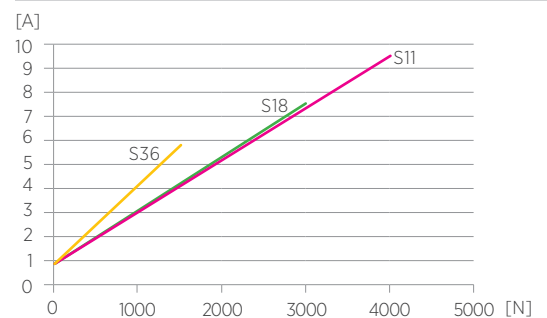

AP-3/V



Effective solution designed for integrated applications
 Integrated and adjustable end-stroke limit switches
 Minimum overall building dimension
 Customizable screw bar and nut
 Full metal body actuator



Effiziente Lösung für die anspruchsvolle Applikation
Integrierte Endschalter
Minimalste Einbaumaße
Kundenspezifische Leistungsübersetzungen
Applikationsspezifische Tragmutter
Metallkorpus

Features Technische Merkmale	
AC Motors AC Motoren	Single-phase 230V 50Hz 230V, 50Hz, 1Ph.
DC Motors DC Motoren	12÷24÷36 V
Built-in nut Tragmutter im Lieferumfang	
Standard protection Schutzart	IP44
Duty cycle Einschaltdauer	S3 10% based on 10 min. S3 10% basierend auf 10 min.
Operating temperature Betriebstemperatur	-10C° ÷ +60C°

Options Optionen	
Analog potentiometer or encoder Permanente analoge (Potentiometer) oder digitale (Hall - Sensor) Lagerückmeldung	
Customizable nut and stroke Kundenspezifische Tragmutter	
Up to 4 cam-activated switches Bis zu vier Schalter- und positionen verfügbar	
Various rear attachments available (0° and 90°) Hintere Befestigung in 0° und 90° verfügbar	

Max thrust Push/Pull [N] Max Kraft Druck / Zug	Max speed [mm/s] Max Geschw.	Stroke length [mm] Hublänge	Installation dim. [mm] Einbaulänge (D)
4000	11	50÷300*	stroke/Hub + 75
3000	18		
1500	36		

*Longer stroke available upon request | Längere Hübe auf Anfrage möglich

Speed vs. Load | Geschwindigkeit / Kraft

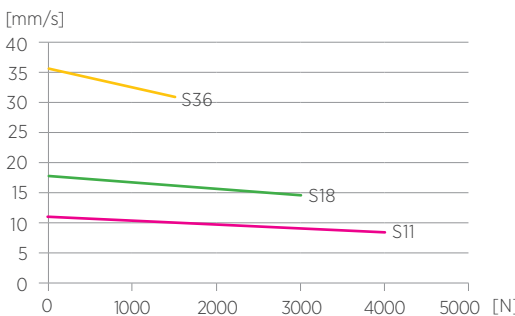

Current vs. Load | Stromaufnahme / Kraft

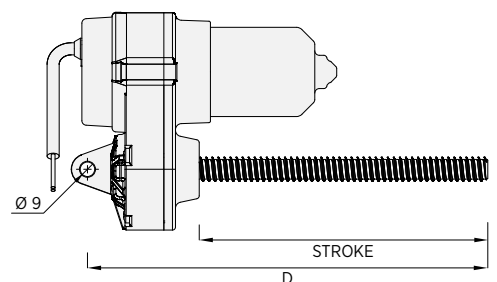
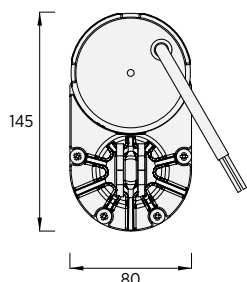
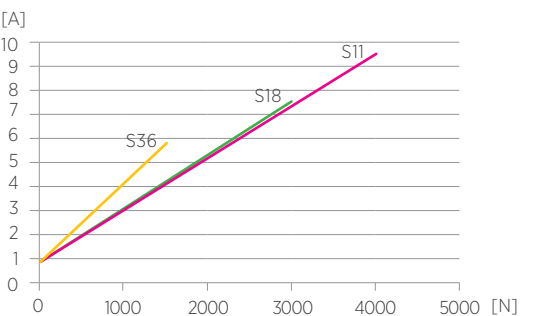

AP-3



- High performance AC own compact design motor
- High efficiency power transmission
- Full metal body actuator
- Integrated and adjustable end-stroke limit switches
- Custom design cam setting

Hochleistungs AC - Kompaktmotor
Hoch effizientes, kraftvolles Getriebe
Metallkorpus
Integrierte Endschalter
Kundenspezifische Endschalter - Schaltpunkte



Features | Technische Merkmale

AC Motors AC Motoren	Single-phase 230V 50Hz 230V, 50Hz, 1Ph.
Standard protection Schutzart	IP44
Duty cycle Einschaltdauer	S3 10% based on 10 min. S3 10% basierend auf 10 min.
Operating temperature Betriebstemperatur	-10C° ÷ +60C°

Options | Optionen

Analog potentiometer or encoder Permanente analoge (Potentiometer) oder digitale (Hall - Sensor) Lagerückmeldung
Customizable stroke and retracted length Kundenspezifische Hübe und eingefahrene Längen
Up to 4 cam-activated switches Bis zu vier Schalter- und positionen verfügbar
Various rear and front attachments available (0° and 90°) Befestigungsaugen in 0° und 90° verfügbar

Max thrust Push/Pull [N] Max Kraft Druck / Zug	Max speed [mm/s] Max Geschw.	Stroke length [mm] Hublänge	Installation dim. [mm] Einbaulänge (D)
6500	3	100÷400*	stroke/Hub + 157
3500	6		

*Longer stroke available upon request | Längere Hübe auf Anfrage möglich

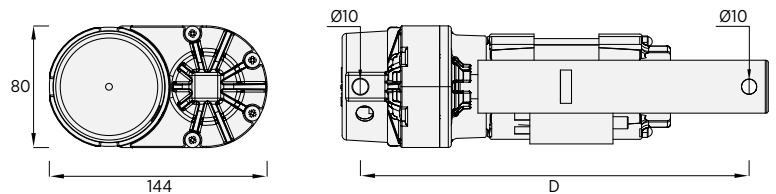

AP-3/C



High performance AC own compact design motor
 Improved IP protection for industrial applications
 High efficiency power transmission
 Full metal body actuator
 Integrated and adjustable end-stroke limit switches
 Custom design cam setting

*Hochleistungs AC Kompaktmotor
 Erhöhte Schutzart für industrielle Applikationen
 Hoch effizientes, kraftvolles Getriebe
 Metallkorpus
 Integrierte Endschalter
 Kundenspezifische Endschalter - Schaltpunkte*

Features | Technische Merkmale

AC Motors AC Motoren	Single-phase 230V 50Hz 230V, 50Hz, 1Ph.
Stainless steel rod Kolbenstange in Edelstahl	
Standard protection Schutzart	IP44
Duty cycle Einschaltdauer	S3 10% based on 10 min. S3 10% basierend auf 10 min.
Operating temperature Betriebstemperatur	-10C° ÷ +60C°

Options | Optionen

Analog potentiometer or encoder Permanente analoge (Potentiometer) oder digitale (Hall - Sensor) Lagerückmeldung
Increased IP Erhöhte Schutzart
Customizable stroke and retracted length Kundenspezifische Hübe und eingefahrene Längen
Up to 4 cam-activated switches Bis zu vier Schalter- und positionen verfügbar
Various rear and front attachments available (0° and 90°) Befestigungsaugen in 0° und 90° verfügbar

Max thrust Push/Pull [N] Max Kraft Druck / Zug	Max speed [mm/s] Max Geschw.	Stroke length [mm] Hublänge	Installation dim. [mm] Einbaulänge (D)
6500	3	100÷400*	stroke/Hub + 116
3500	6		

*Longer stroke available upon request | Längere Hübe auf Anfrage möglich

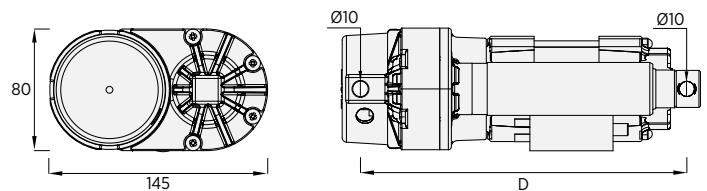

RAMB-01 LINE

Smart and effective solution, that joins a unique design with the needs of mass-production.
Up to 500N.

*Bietet durchdachte und effektive Lösungen in Verbindung mit individuellem Design. Diese Produktlinie erfüllt alle Anforderungen, die speziell in der industriellen Serienfertigung gestellt werden.
Leistungen bis 500N.*



**Ramb-01/M
Ramb-01/SP
Ramb-01/TH
APF-01**

RAMB-01/M



Cool and innovative design
 Compact building dimension
 Integrated end-stroke limit switches

*Außergewöhnliches und innovatives Design
 Kompakte Einbaumaße
 Integrierte Endlagenschalter*



Different front attachment available
Unterschiedliche Spindelseitige Aufnahmen

Features | Technische Merkmale

DC Motors DC Motoren	12÷24÷36 V
Standard protection Schutzart	IP44
Duty cycle Einschaltdauer	S3 10% based on 10 min. S3 10% basierend auf 10 min.
Operating temperature Betriebstemperatur	-10C° ÷ +60C°

Options | Optionen

Increased IP Erhöhte Schutzart
Customizable stroke Kundenspezifische Hübe
Various rear and front attachments available (0° and 90°) Befestigungsaugen in 0° und 90° Ausführung

Max thrust Push/Pull [N] Max Kraft Druck / Zug	Max speed [mm/s] Max Geschw.
500	12
350	24
250	36

Speed vs. Load | Geschwindigkeit / Kraft

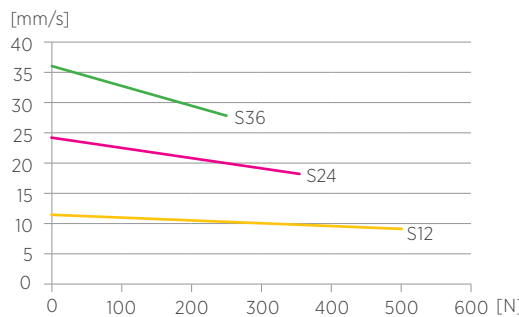

Current vs. Load | Stromaufnahme / Kraft

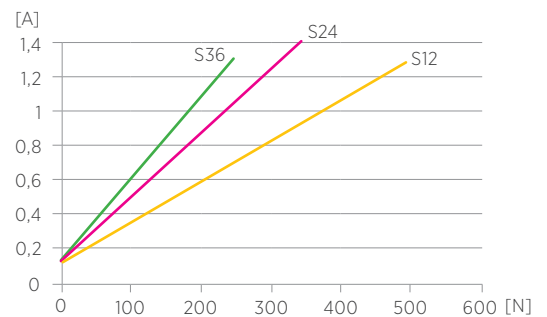

Stroke length [mm] Hublänge	Installation dim. [mm] Einbaulänge (D)
max 65	189,5
max 100	224,5
max 135	248,5

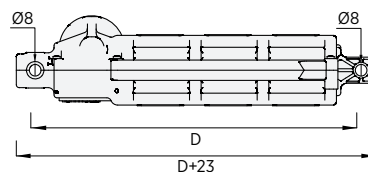
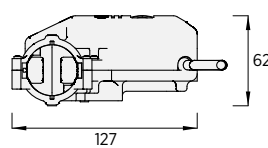

RAMB-01/SP



Built-in spring for a controlled thrust
 Integrated end-stroke limit switches
 Rod with slot front attachment

Interne Feder zur kontrollierten Kraftabsorption
Integrierte Endlagenschalter
Spindelseitige Aufnahme geschlitzt



Features Technische Merkmale	
DC Motors DC Motoren	12÷24÷36 V
Standard protection Schutzart	IP44
Duty cycle Einschaltdauer	S3 10% based on 10 min. S3 10% basierend auf 10 min.
Operating temperature Betriebstemperatur	-10C° ÷ +60C°
Options Optionen	
Increased IP Erhöhte Schutzart	
Various rear and front attachments available (0° and 90°) Befestigungsaugen in 0° und 90° Ausführung	

Max thrust Push/Pull [N] Max Kraft Druck / Zug	Max speed [mm/s] Max Geschw.
500	12
350	24
250	36

Speed vs. Load | Geschwindigkeit / Kraft

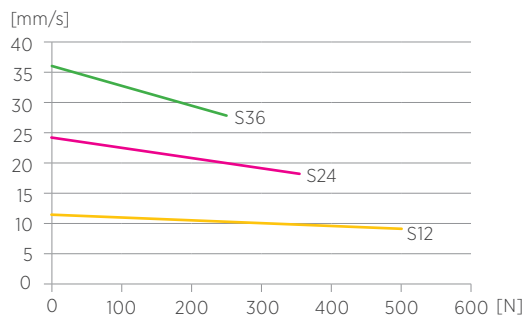

Current vs. Load | Stromaufnahme / Kraft

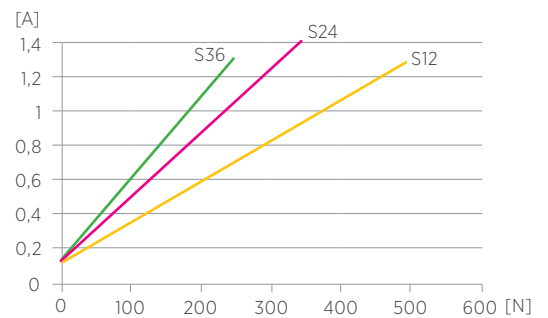

Compression spring Feder Kompressionsdruck	Pressure load [N] Druckkraft	Spring type Federausführung
35	170	a
35	100	b

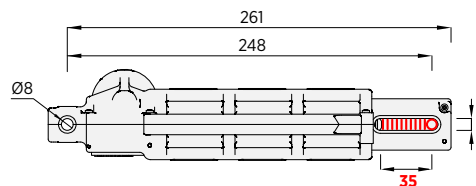
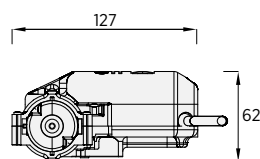

RAMB-01/TH



Integrated bracket for easy installation, far away from engine's vibrations

Full technopolymer housing, totally insulated from eddy current, ideal for generator applications

Designed to fit throttle cable and to set sheath's tension

Integrated adjustable end-stroke limit switches

Integrierte Montagekonsole zur einfachen Installation, z. B. abseits von Motorvibrationen

Kunststoffgehäuse, vollisoliert zur Vermeidung von elektr. Störungen Somit ideal für Anwendungen in Kombination mit Generatoren

Konstruiert für die Aufnahmen von Gaszügen und deren Ummantelungen

Integrierte und einstellbare Endschalter



Features | Technische Merkmale

DC Motors DC Motoren	12÷24÷36 V
Maintenance free Wartungsfrei	
Standard protection Schutzart	IP44
Operating temperature Betriebstemperatur	-10C° ÷ +80C°

Options | Optionen

Increased IP Erhöhte Schutzart
Customizable stroke Kundenspezifische Hübe

Max thrust Push/Pull [N] Max Kraft Druck / Zug	Max speed [mm/s] Max Geschw.	Stroke length [mm] Hublänge	Installation dim. [mm] Einbaulänge (D)
300	1,6	max 50*	285
	2,8		
	5		

*Longer stroke available upon request | Längere Hübe auf Anfrage möglich

Speed vs. Load | Geschwindigkeit / Kraft

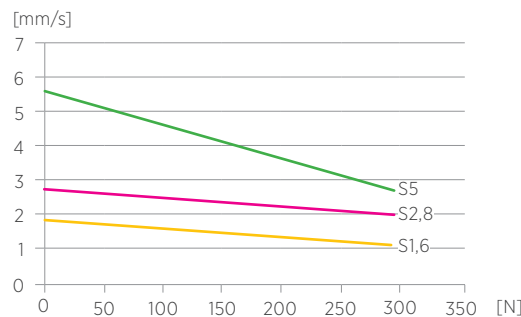

Current vs. Load | Stromaufnahme / Kraft

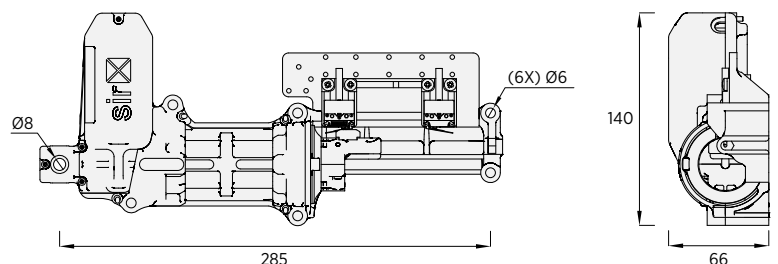
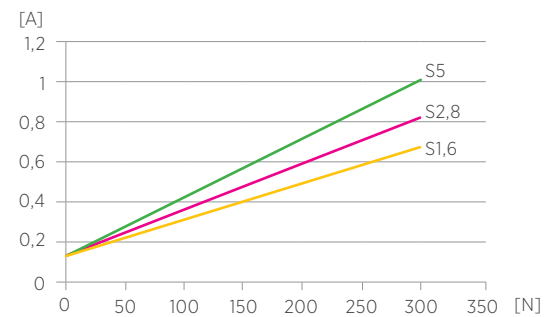

APF-01



APF-01 is the innovative solution for drawers automation
 Effective solution designed for mass production needs
 Narrow design to fit in furniture's technical compartment
 Can be manually operated in case of missing power

*APF-01 ist die innovative Lösung für die Automation von
 Ausschüben und Schubladen.*

*Entwickelt für die Anforderungen der industriellen
 Großserienfertigung.*

*Durch das zierliche Design einfach in kleinste
 Zwischenräume von Möbeln zu installieren.*

Manuelle Betätigung bei Stromausfall

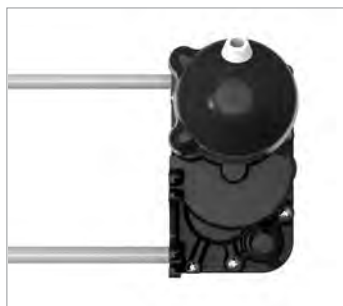

Features | Technische Merkmale

DC Motors DC Motoren	12÷24÷36 V
Maintenance free Wartungsfrei	
Standard protection Schutzart	IP44
Duty cycle Einschaltdauer	S3 10% based on 10 min S3 10% basierend auf 10 min.
Operating temperature Betriebstemperatur	-10C° ÷ +60C°

Options | Optionen

Encoder Permanente, digitale Lagerückmeldung
Customizable stroke and retracted length Kundenspezifische Hübe und eingefahrene Längen

Max thrust Push/Pull [N] Max Kraft Druck / Zug	Max speed [mm/s] Max Geschw.	Stroke length [mm] Hublänge	Installation dim. [mm] Einbaulänge (D)
300	100	100÷500	stroke/Hub + 25

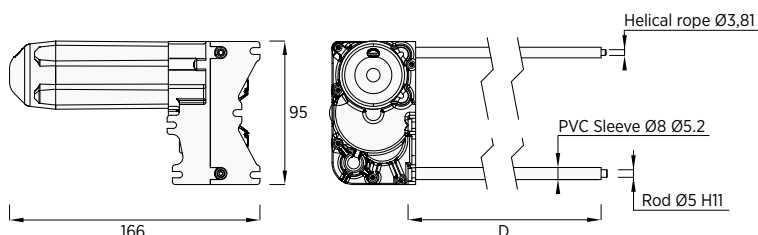

RAO LINE

Worm gearmotor family.
Oversized bearings for high resistance to
radial and axial loads.

*Familie der Schneckenrad -
Getriebmotoren.
Überdimensionierte Kugellager
garantieren die höchste
Widerstandsfähigkeit gegen radiale und
axiale Belastungen.*



**RAO-02
RAO-4
SLIM2.1**

RAO-02



Compact full metal body design
 High gear ratio in a small gearbox dimension
 Various gear ratio available to achieve 17 - 72 rpm range
 Built-in encoder with high resolution

*Kompakte Metallausführung
 Beste Übersetzungsverhältnisse trotz kleiner Getriebe
 Verschiedene Übersetzungen ermöglichen die Abdeckung einer Bandbreite von 17 - 72 Umdrehungen / min.
 Permanente digitale Lagerrückmeldung mit hoher Auflösung*

Features Technische Merkmale	
DC Motors DC Motoren	12÷24÷36 V
Maintenance free Wartungsfrei	
Duty cycle Einschaltdauer	S3 10% based on 10 min. S3 10% basierend auf 10 min.
Operating temperature Betriebstemperatur	-10C° ÷ +60C°

Options Optionen	
Encoder Permanente, digitale Lagerrückmeldung	

Torque S1 [Nm] Drehmoment S1	Torque S3 10% [Nm] Drehmoment S3 10%	Max Torque [Nm] Drehmoment Max	Speed up to [rpm] Max Geschw.	RR
5	7,8	8	17	1/400
2,9	4,6	8	37	1/190
1,7	2,6	4,5	72	1/90

Speed vs. Load | Geschwindigkeit / Kraft

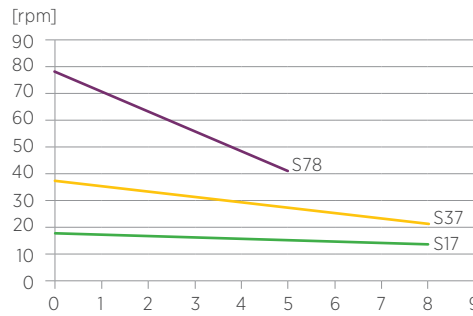

Current vs. Load | Stromaufnahme / Kraft

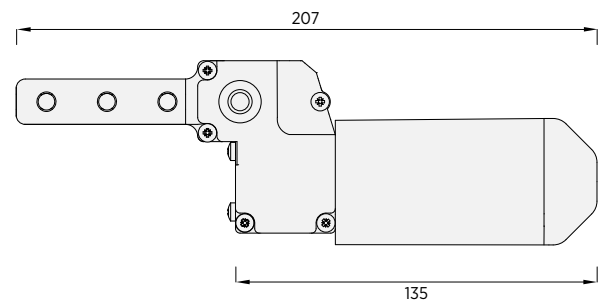
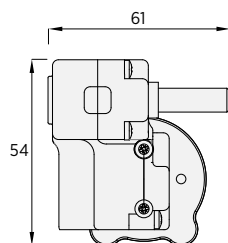
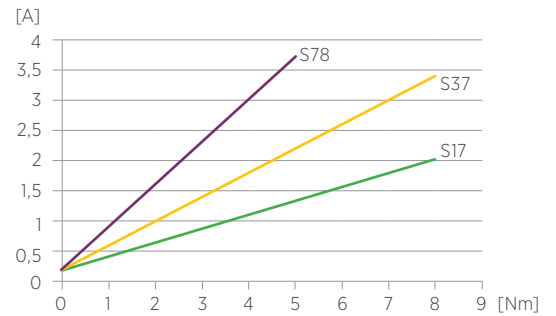

RAO-4



- Silent working worm gearbox
- Oversized bearings for high resistance to radial and axial loads
- Compact full metal body design
- High gear ratio in a small gearbox dimension
- Various gear ratio available to achieve 48 - 195 rpm range
- Built-in encoder without affecting the standard overall dimensions

Sehr leise arbeitendes Getriebe
Überdimensionierte Kugellager für höchste Widerstandsfähigkeit gegen axiale und radiale Kräfte
Kompakte Metallausführung
Beste Übersetzungsverhältnisse trotz kleiner Getriebe
Verschiedene Übersetzungen ermöglichen die Abdeckung einer Bandbreite von 48 - 195 Umdrehungen / min.
Permanente Lagerrückmeldung ohne Veränderung der Einbaumaße



Features | Technische Merkmale

DC Motors DC Motoren	12÷24÷36 V
Maintenance free Wartungsfrei	
Duty cycle Einschaltdauer	S3 10% based on 10 min. S3 10% basierend auf 10 min.
Operating temperature Betriebstemperatur	-10C° ÷ +60C°

Options | Optionen

Encoder Permanente, digitale Lagerrückmeldung

Torque S1 [Nm] Drehmoment S1	Torque S3 10% [Nm] Drehmoment S3 10%	Max Torque [Nm] Drehmoment Max	Speed up to [rpm] Max Geschw.	RR
6	13	25	48	1/69
2,8	7,3	25	75	1/69
1,2	3,54	12	195	1/26

Speed vs. Load | Geschwindigkeit / Kraft

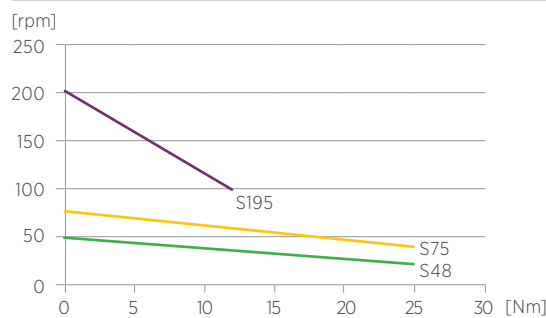

Current vs. Load | Stromaufnahme / Kraft

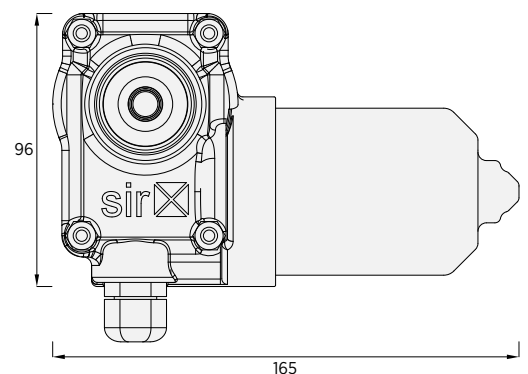
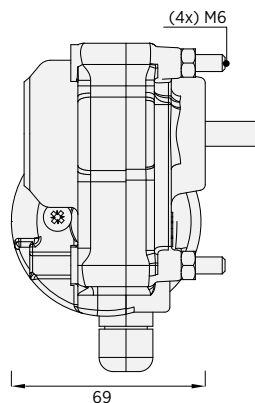
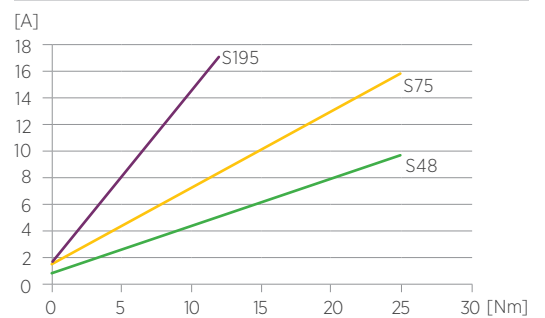

SLIM2.1



- Compact full metal body design
- High gear ratio in a small gearbox dimension
- Extremely low speed from 0,8 to 1,5 rpm
- Very-high torque values 40 - 60 Nm
- Built-in encoder with high resolution

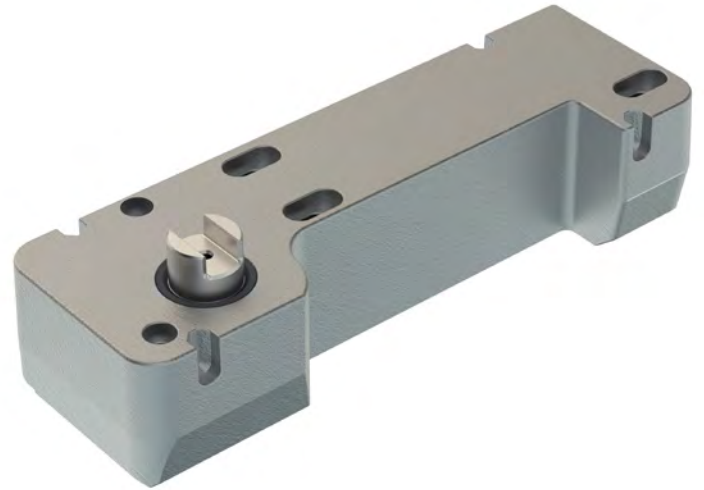

- Kompakte Metallausführung*
- Beste Übersetzungsverhältnisse trotz kleiner Getriebe*
- Extrem niedrige Geschwindigkeiten von 0,8 bis 1,5 rpm*
- Sehr hohe Drehmomente von 40 bis 60 Nm*
- Permanente digitale Lagerückmeldung mit hoher Auflösung*

Features | Technische Merkmale

DC Motors DC Motoren	24 V
Maintenance free Wartungsfrei	

Options | Optionen

Encoder Permanente, digitale Lagerückmeldung
--

Type Modell	Max Torque [Nm] Drehmoment Max	Speed up to [rpm] Max Geschw.	RR
080	60	0,8	1/8750
145	40	1,5	1/4350

Speed vs. Load | Geschwindigkeit / Kraft

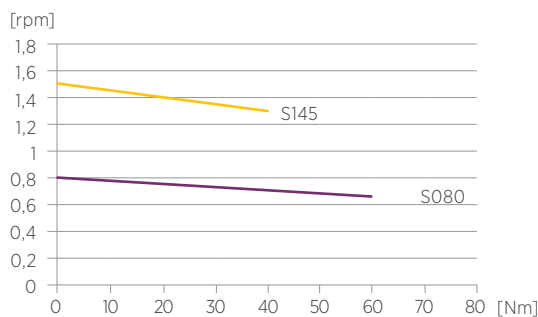

Current vs. Load | Stromaufnahme / Kraft

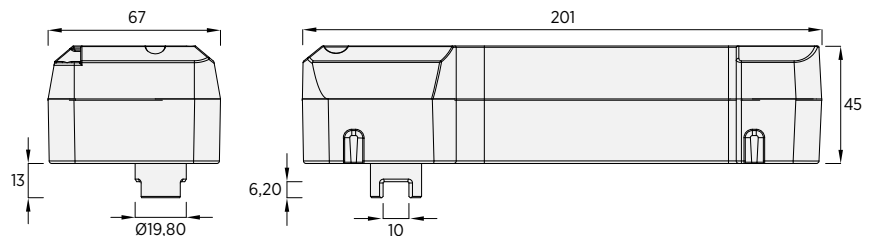
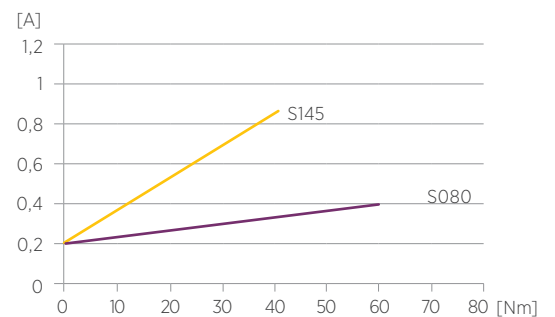

TECH FOCUS ON:

TRI-X

Specific solution for long stroke combined with minimum compact built in dimension.

3 profiles / 2 stages scopic column to achieve a high bending moment resistance. Robust and reliable internal actuation system through double solid steel screw bar. Double set of slides on each side of the column for high stability degree. High customizable in dimensions, speed, push force.

Besondere Lösung für große Hublängen in Kombination mit minimalen Einbaulängen.

2 - stufige Teleskop - Hubsäule mit 3 Profilen widersteht höchsten Biegemomenten. Strapazierfähiges und zuverlässiges integriertes Antriebssystem mit massivem Doppel-Spindel Antrieb.

Zwei massive Gleiter an jeder Seite garantieren höchste Steifigkeit und Stabilität. Umfangreich individualisierbar hinsichtlich Längen, Übersetzungen und mechanischer Anschlüsse.



SYNCRO

Nice and elegant synchronization system with built-in electronics (no external box needed).

Synchronization available for all the Schumo scopic profiles design specific. Soft Start and Stop, ammeter control, up/down settable different speeds as standard integrated features.

CPU built-in solution for a flexible and precise synchronized movement. AC and DC motor synchronized solution.

Elegantes synchronisiertes Parallelsystem mit integrierter Steuerung (keine zusätzlichen externen Boxen notwendig).

Synchronisierter Parallellauf ist für alle Schumo Hubsäulen Ausführungen erhältlich. Soft Start und Stopp, Lastabhängige Überwachung und Abschaltung, Auf/Ab - Umschaltung, einstellbare Geschwindigkeiten sind Standard Merkmale. Integrierter Prozessor sorgt für eine flexible und präzise synchronisierte Bewegung.

Synchronisierter Parallellauf ist für AC und DC Lösungen erhältlich.



DUAL DRIVE

Specific solution for the combinations of high speed and high push force. Speed up to double compared to standard scopic solution.

Suitable for long stroke scopic column.

Robust and reliable built-in twin actuation system.

Double set of slides on each side of the column for high stability degree.

High customizable in dimensions, speed, push force.

Speziell entwickelt um den Anforderungen an hohe Verfahrensgeschwindigkeiten bei großen Lasten gerecht zu werden.

Verdoppelung der Verfahrensgeschwindigkeit im Vergleich zu Standard Teleskop - Hubsäulen. Ideal für lange Hubwege.

Strapazierfähiges und zuverlässiges integriertes Antriebssystem mit massivem Doppel-Spindel Antrieb.

Zwei massive Gleiter an jeder Seite garantieren höchste Steifigkeit und Stabilität. Umfangreich individualisierbar hinsichtlich Längen, Übersetzungen und mechanischer Anschlüsse.

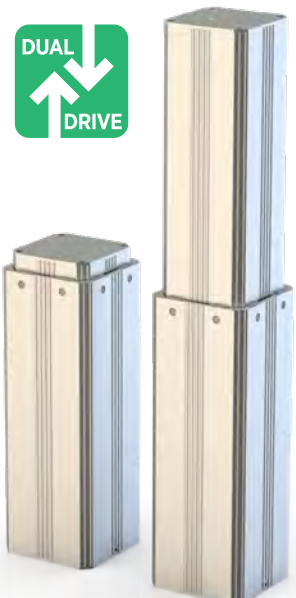

L SCOPIC

Is the smart and effective column,
suitable for a wide range of applications.

*Ist die smarte und effektive Hubsäule für
die unterschiedlichsten Anwendungen.*

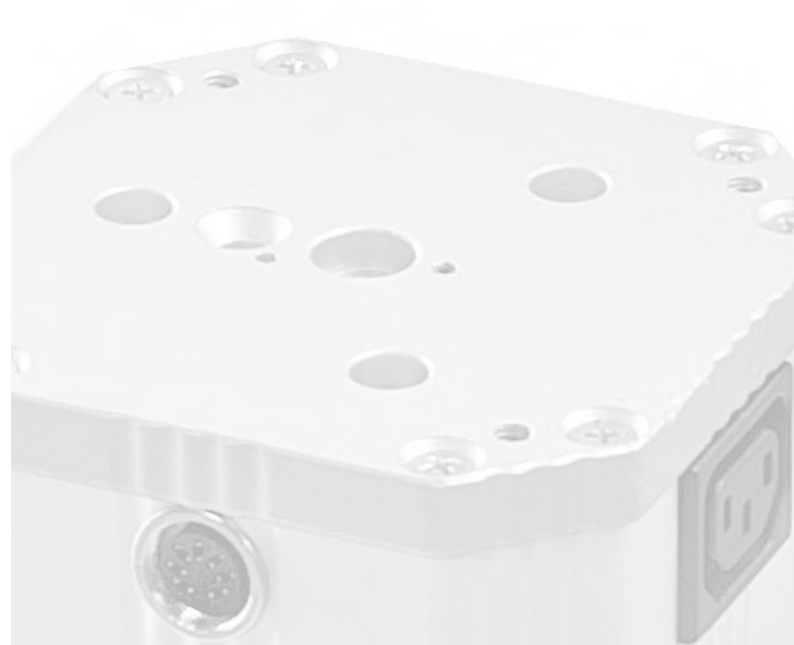

L SCOPIC





- Elegant appearance for in-view solutions
- Plug & Play
- High customizable in dimensions, wirings and hardware connections
- AC worldwide multi-tension solution available
- Gearless AC power transmission for very silent operation

Das elegante Erscheinungsbild prädestiniert diese Hubsäule für den Einsatz in sichtbaren Applikationen.

Plug & Play

Voll individualisierbar hinsichtlich Abmessungen, Kabeldurchführungen sowie elektrischer und mechanischer Anschlüsse

*AC - Multispannungsausführung - Eine Säule für weltweiten Einsatz
Getriebelose, kraftvolle AC Motorübersetzung für extrem leisen Betrieb*



Features | Technische Merkmale

Maintenance free <i>Wartungsfrei</i>	
Built-in auxiliary sockets <i>Integrierte Steckdose(n)</i>	
Quiet operation <i>Geräuscharm</i>	
Anodized aluminum profiles <i>Eloxiertes Aluminiumprofil</i>	
Standard protection <i>Schutzart</i>	IP44
Duty cycle <i>Einschaltdauer</i>	S3 10% based on 10 min. <i>S3 10% basierend auf 10 min.</i>
Operating temperature <i>Betriebstemperatur</i>	-10C° ÷ +60C°

Options | Optionen

Controlled by a Sir low voltage controller <i>Ansteuerbar durch Sir Hand- und Fusschalter</i>
Customized cables inside the column <i>Kabelführungen innerhalb der Säule</i>
Different built-in auxiliary sockets <i>Verschiedene Anschlussbuchsen einbaubar</i>
Customizable strokes and retracted lengths <i>Kundenspezifische Hübe, Einbaulängen und Anschlussplatten</i>
Synchronized versions <i>Synchronisierter Parallelbetrieb</i>
Encoder <i>Permanente, digitale Lagerückmeldung</i>



Single Drive <i>Einzelantrieb</i>	Thrust up to [N] <i>Max Kraft</i>	Max speed [mm/s] <i>Max Geschw.</i>	Stroke length [mm] <i>Hublänge</i>	Installation dim. [mm] <i>Einbaulänge (D)</i>
AC 100 - 120 - 240 V - 50/60Hz DC 12 - 24 - 36 V MULTITENSION 100 - 240 V - 50/60Hz	750 - 2500	5 - 30	100÷300*	stroke/Hub + 140
 Syncro	Thrust up to [N] (twin set) <i>Max Kraft bis zu (Parallelsystem)</i>	Max speed [mm/s] <i>Max Geschw.</i>	Stroke length [mm] <i>Hublänge</i>	
AC 100 - 120 - 240 V - 50/60Hz MULTITENSION 100 - 240 V - 50/60Hz	1500 - 3000	5 - 15	100÷300*	

*Longer stroke available upon request | *Längere Hübe auf Anfrage möglich*

Profiles | *Profilgröße*

Fixing plates | *Befestigungsplatten*

2L

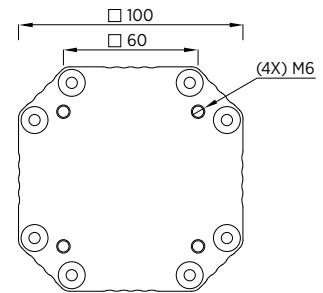
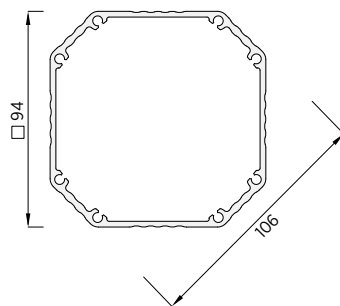

3L

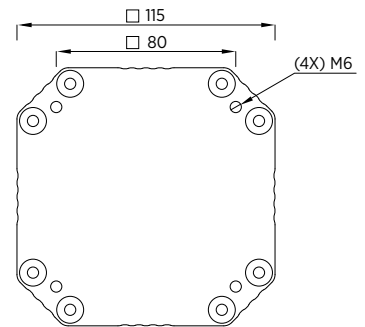
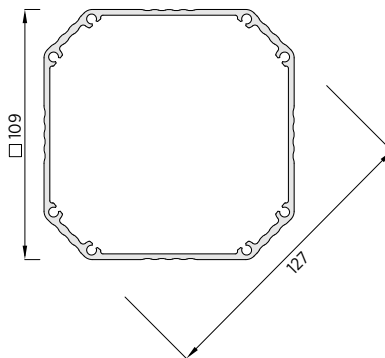

4L

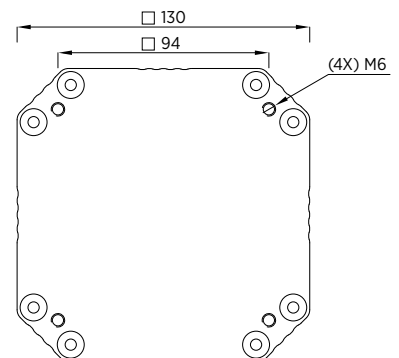
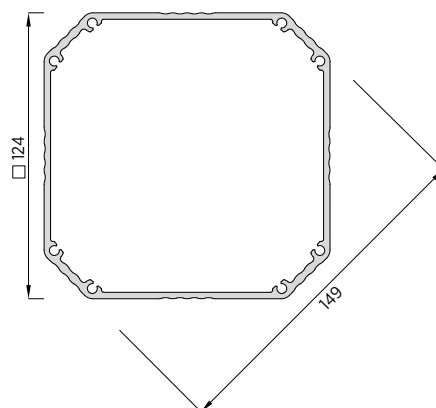

R SCOPIC

Smart and effective column, suitable for offset loads.
Up to 6000N.

Intelligente und effiziente Hubsäule für schwergewichtige Anwendungen. Aufgrund der hohen Steifigkeit äußerst geeignet für dezentrale Belastung. Leistungen bis 6000N



R SCOPIC





- Robust appearance for in-view solutions
- High customizable in dimensions, wirings and hardware connections
- Plug & Play
- AC worldwide multi-tension solution available
- Gearless AC power transmission for very silent operation

Robustes auftreten und dennoch ansprechendes Erscheinungsbild für die Verwendung in sichtbaren Applikationen.

Voll individualisierbar hinsichtlich Abmessungen, Kabeldurchführungen sowie elektrischer und mechanischer Anschlüsse

Plug & Play

AC - Multispannungsausführung - Eine Säule für weltweiten Einsatz

Getriebelose, kraftvolle AC Motorübersetzung für extrem leisen Betrieb

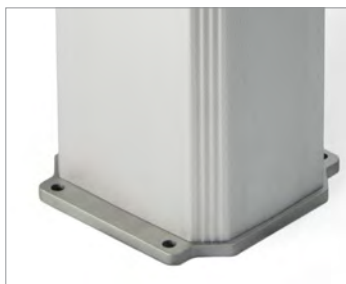

Features | Technische Merkmale

High resistance against bending moments <i>Hält hohen Biegemomenten stand</i>	
Maintenance free <i>Wartungsfrei</i>	
Built-in auxiliary sockets <i>Integrierte Steckdose(n)</i>	
Quiet operation <i>Geräuscharm</i>	
Anodized aluminum profiles <i>Eloxiertes Aluminiumprofil</i>	
Standard protection <i>Schutzart</i>	IP44
Duty cycle <i>Einschaltdauer</i>	S3 10% based on 10 min. <i>S3 10% basierend auf 10 min.</i>
Operating temperature <i>Betriebstemperatur</i>	-10C° ÷ +60C°

Options | Optionen

Controlled by Sir low voltage controller <i>Ansteuerbar durch Sir Hand- und Fusschalter</i>
Customized cables inside the coloumn <i>Kabelführungen innerhalb der Säule</i>
Different built-in auxiliary sockets <i>Verschiedene Anschlussbuchsen einbaubar</i>
Customizable strokes and retracted lengths <i>Kundenspezifische Hübe, Einbaulängen und Anschlussplatten</i>
Synchronized versions <i>Synchronisierter Parallelbetrieb</i>
Encoder <i>Permanente, digitale Lagerückmeldung</i>



Single Drive <i>Einzelantrieb</i>	Thrust up to [N] <i>Max Kraft</i>	Max speed [mm/s] <i>Max Geschw.</i>	Stroke length [mm] <i>Hublänge</i>	Installation dim. [mm] <i>Einbaulänge (D)</i>
AC 100 - 120 - 240 V - 50/60Hz DC 12 - 24 - 36 V MULTITENSION 100 - 240 V - 50/60Hz	1000 - 6000	5 - 30	100÷400*	stroke/Hub + 140

 Tri-X	Thrust up to [N] <i>Max Kraft</i>	Max speed [mm/s] <i>Max Geschw.</i>	Stroke length [mm] <i>Hublänge</i>
AC 100 - 120 - 240 V - 50/60Hz DC 12 - 24 - 36 V MULTITENSION 100 - 240 V - 50/60Hz	2500	10	300÷800*
	1500	20	
	850	30	

 Syncro	Thrust up to [N] (twin set) <i>Max Kraft bis zu (Parallelsystem)</i>	Max speed [mm/s] <i>Max Geschw.</i>	Stroke length [mm] <i>Hublänge</i>
AC 100 - 120 - 240 V - 50/60Hz MULTITENSION 100 - 240 V - 50/60Hz	1500 - 3000	5 - 15	100÷300*

 Dual Drive	Thrust up to [N] <i>Max Kraft</i>	Max speed [mm/s] <i>Max Geschw.</i>	Stroke length [mm] <i>Hublänge</i>	Installation dim. [mm] <i>Einbaulänge (D)</i>
DC 12 - 24 - 36 V	4000	13	300÷800*	stroke/Hub + 150
	2000	30		

*Longer stroke available upon request | *Längere Hübe auf Anfrage möglich*

Profiles | *Profilgröße*

Fixing plates | *Befestigungsplatten*

1R

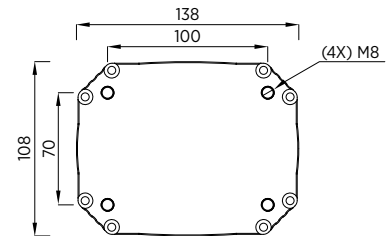
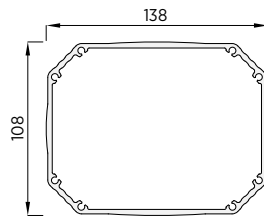

2R

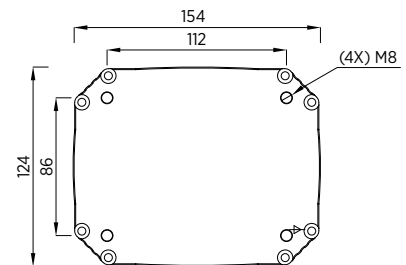
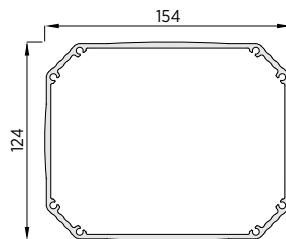

3R

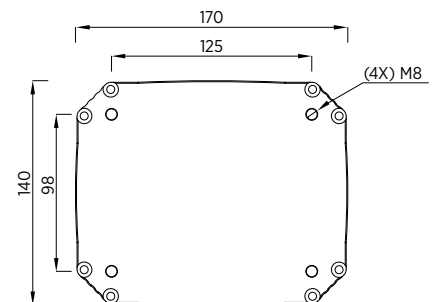
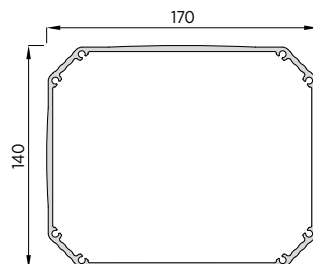

Accessories

Zubehör



ELECTRIC BOARDS

The synergy with the sister company Italsea allows SIR to get access to a large choice of drive electric boards

High customizable in functions and features

Multitension

(12V - 24V - 36V - 100/240V 50/60Hz)

Available for all actuators and scopics design

Minimized dimensions for built-in applications available

Synchronization ready solutions for actuators and scopics

Custom design on demand

Durch die partnerschaftliche Zusammenarbeit mit der Schwestergesellschaft Italsea hat SIR die Möglichkeit eine große Auswahl an elektrischen Motorsteuerungen für unterschiedlichste Anforderungen anzubieten

Funktionen und Parameter sind auf die Kundenbedürfnisse anpassbar

Verfügbar für alle Betriebsspannungen (12V - 24V - 36V - 100/240V 50/60Hz)

Erhältlich für alle Linearantriebe und Teleskop - Hubsäulen

Kompakte Abmessungen für Einbaulösungen

Parallelaufsteuerungen für Linearantriebe und Teleskop - Hubsäulen

Kundenspezifische Ausführungen auf Nachfrage

Control board | Motorsteuerung

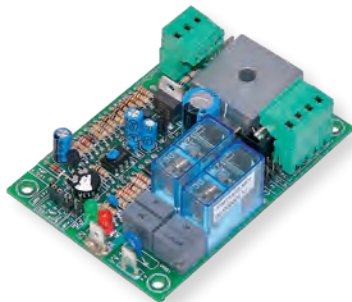

Control board - 1 channel | 1 Kanal - Motorsteuerung



Control board - 2 channel | 2 Kanal - Motorsteuerung



Control board - 3 channel | 3 Kanal - Motorsteuerung



Analogic encoder | Analoge Lagerückmeldung



HANDSET & FOOTSWITCH

HANDSCHALTER & FUSSSCHALTER

Controls hardware available for all the Scopic with built-in electric board

Elegant appearance for in-view solutions

Robust and reliable design

Safe touch in any condition - low voltage supplied

60601-1 / 60601-1-2 available

Bedienelemente für alle Teleskop - Hubsäulen mit integrierter Steuerelektronik

Ansprechende Optik

Robuste und zuverlässige Ausführung

Berührungssicher in jedem Betriebszustand - Niedervolt Technologie

60601-1 / 60601-1-2 verfügbar

Handset | Unterbaushalter



Handset | Unterbaushalter



Handset | Handschalter



Footswitch | Fußschalter





SIR Srl | Via Gasdotto, 65 36078 Valdagno | Vicenza | Italy
T +39 0445 431607 | F +39 0445 431427 | info@siractuators.com | siractuators.com



www.amergroup.it