

Profile

- Most-used size in slim design
- Hollow shaft, max. \varnothing 20 mm
- Counter with 5 decades and fine reading
- Display can be designed for "mm" or "inch"
- Magnifying function for good readability
- Stainless-steel driving shaft as an option
- Axial seal, dustproof and splash-proof
- Clamping plate (see accessories)

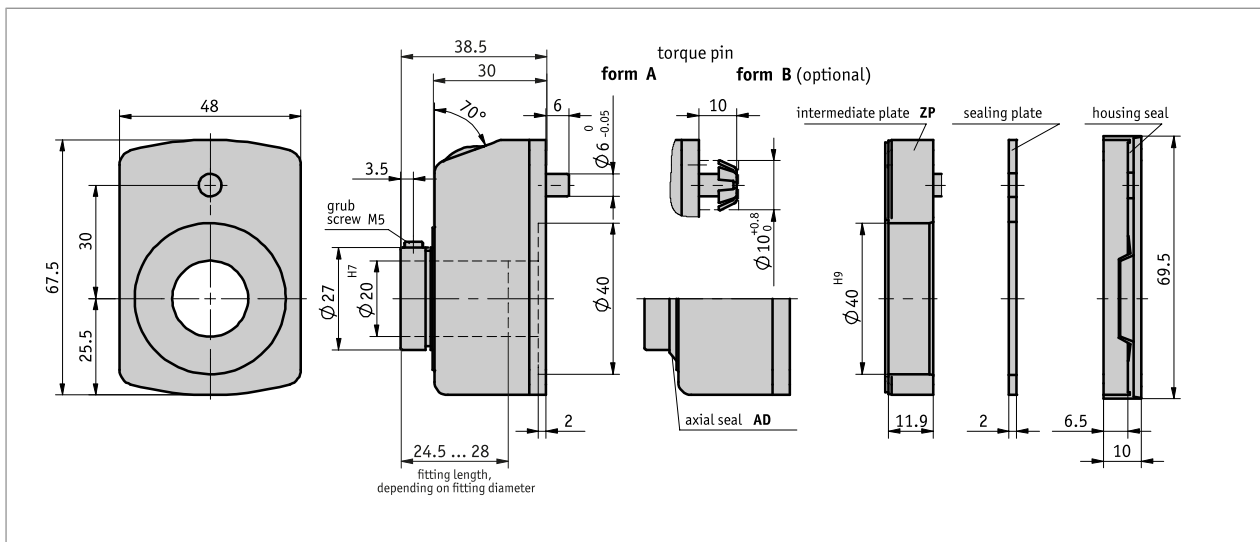

Mechanical data

Feature	Technical data	Additional information
Housing	reinforced plastic	
	zinc die-cast	MCM housing
Sight window	plastic	mineral glass as an option
Counter	5 Decades with fine reading	
Digit height	~7 mm	
Weight	0.1 kg	

■ max. speed

Display (after 1st revolution)	max. speed [rpm]
00010	500 (1500)
00015	500 (1000)
00020	500 (750)
00025	500 (600)
00030	500
00040	375
00050	300
00060	250
00080	180
00100	150

 Speeds >500 rpm must only be run for short periods.

Formula:



$$\text{max. speed} = \frac{15000}{\text{indication after 1st revolution}}$$

Ambient conditions

Feature	Technical data	Additional information
Ambient temperature	0 ... 80 °C	

Order

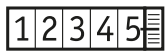
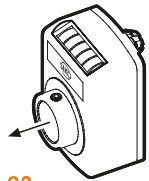
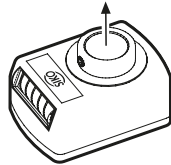
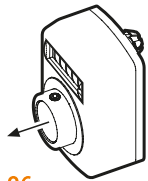
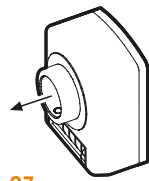
■ Ordering information

Display	Mounting position				Counting direction
					
	02	04	06	07	

Note: Highlights in orange are order features.

■ Ordering table

Feature	Ordering data	Spezifikation	Additional information
Mounting position	A ...	02, 04, 06, 07	see the icons illustrating the mounting positions
indication after 1st revolution	B ...	10, 12/5, 15, 15/75, 17/5, 20, 25, 30, 39/375, 40, 50, 60, 78/75, 80, 100 others on request	/5 = arithmetical value not displayed
decimal place	C 0 1 2 3 4	0 = 00000 1 = 0000.0 2 = 000.00 3 = 00.000 4 = 0.0000	
Counting direction	D i e	clockwise ascending values counter-clockwise ascending values	
hollow shaft/diameter	E 20	ø20 mm RH8, RH10, RH12, RH14, RH18 VA8, VA10, VA14, VA20	reducing bushes stainless steel
Housing	F 0 S GR FR MCM	orange RAL 2004 black RAL 9005 gray RAL 7035 red RAL 3000 chromatized matt	plastic plastic plastic plastic metal

Feature	Ordering data	Spezifikation	Additional information
seal	G	OAD	without axial seal
		AD	with axial seal
		GD	with axial and housing seal
Intermediate plate	H	OZP	without intermediate plate
		ZP	with intermediate plate
			"not with seal ""GD"""

■ Order key

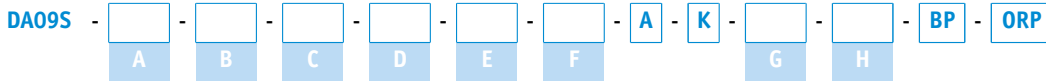

Scope of delivery:
DA09S



Accessories you can find:
Clamping plate KP09
Pneumatic clamping plate KP09P
Clamping plate KPL09
Adapter sleeve RH

www.siko-global.com
www.siko-global.com
www.siko-global.com
www.siko-global.com